

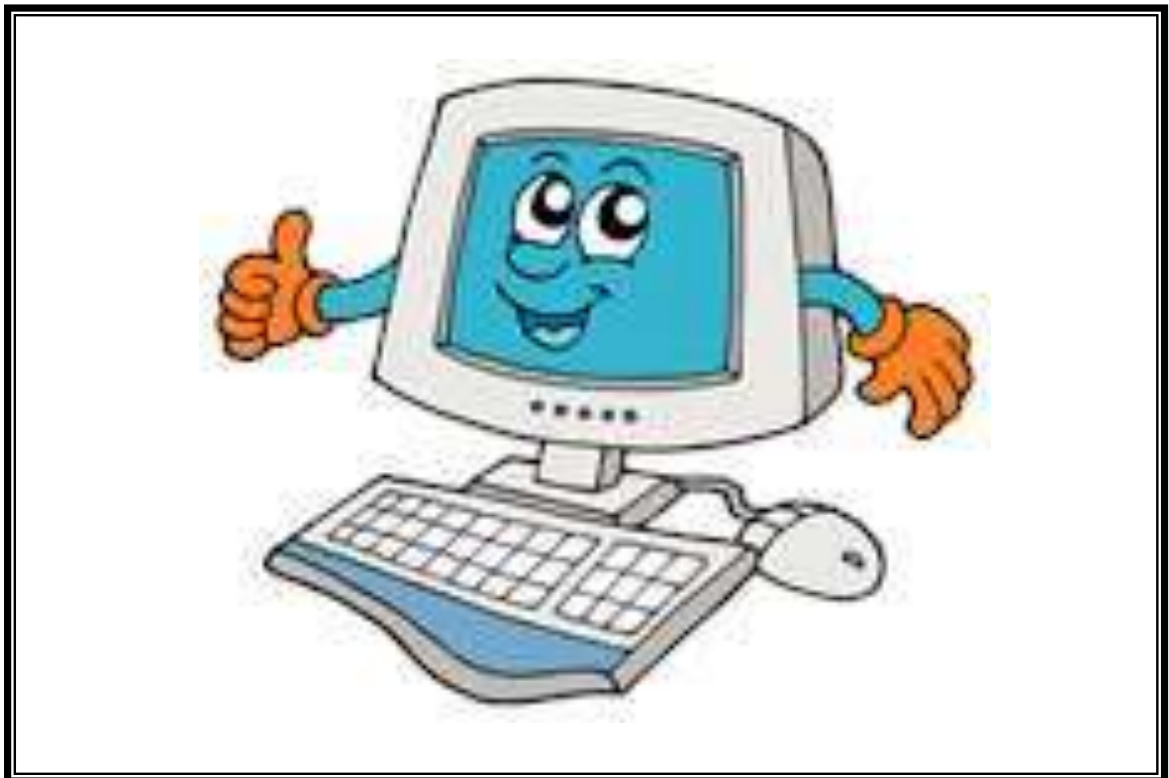

Republic of the Philippines
DEPARTMENT OF EDUCATION



K to 12 Basic Education Curriculum Technology and Livelihood Education Learning Module



COMPUTER HARDWARE SERVICING

EXPLORATORY COURSE

Grade 7 and Grade 8

TABLE OF CONTENTS

What Is This Module About?	2
How Do You Use This Module	3
LESSON 1 – Use Hand Tools	4 – 30
LESSON 2 – Perform Mensuration and Calculation	31 – 46
LESSON 3 –Prepare and Interpret Technical Drawing	47 – 63
LESSON 4 – Practice Occupational Safety and Health.....	64 - 103
Answer Keys	104 - 111
Acknowledgment.....	112



What Is This Module About?

Welcome to the world of **Computer Hardware Servicing!**

This Module is an exploratory course which leads you to **Computer Hardware Servicing** National Certificate Level II (NC II)¹. It covers the **4** common competencies that a Grade 7 / Grade 8 Technology and Livelihood Education (TLE) student like you ought to possess, namely:

- 1) Using hand tools;
- 2) Performing mensuration and calculation;
- 3) Preparing and interpreting technical drawing; and
- 4) Practicing occupational health and safety procedures.

These **4** common competencies are covered separately in 4 Lessons. As shown below, each Lesson is directed to the attainment of two or more learning outcomes:

Lesson 1 – **Use Hand Tools**

Learning Outcome (LO) 1 - Prepare hand tools

Learning Outcome (LO) 2- Use appropriate hand tools and test equipment

Learning Outcome (LO) 3 - Maintain hand tools

Lesson 2 –**Perform Calculation and Mensuration**

Learning Outcome (LO) 1 - Select components to be measured

Learning Outcome (LO) 2 - Carry out measurements and calculation

Lesson 3 –**Prepare and Interpret Technical Drawing**

Learning Outcome (LO) 1 - Identify different kinds of technical drawing

Learning Outcome (LO) 2 - Interpret technical drawing

Lesson 4 –**Practice Occupational Health and Safety Procedures**

Learning Outcome (LO) 1 - Identify hazards and risks

Learning Outcome (LO) 2 - Evaluate hazards and risks

Learning Outcome (LO) 3 - Control hazards and risks

Your success in this exploratory course on **Computer Hardware Servicing** is shown in your ability to perform the performance standards found in each learning outcome.

¹**NATIONAL CERTIFICATE (NC)** is a certification issued to individuals who achieved all the required units of competency for a national qualification as defined under the Training Regulations. NCs are aligned to specific levels within the PTQF. (**TESDA Board Resolution No. 2004-13, Training Regulations Framework**)

NATIONAL CERTIFICATE LEVEL refers to the four (4) qualification levels defined in the Philippine TVET Qualifications Framework (PTQF) where the worker with:

a. **NC I** performs a routine and predictable tasks; has little judgment; and, works under supervision;

b. **NC II** performs prescribed range of functions involving known routines and procedures; has limited choice and complexity of functions, and has little accountability;



How Do You Use This Module?

This Module has 4 Lessons. Each Lesson has the following parts.

- Learning Outcomes
- Performance Standards
- Materials/Resources
- Definition of Terms
- What Do You Already Know?
- What Do You Need to Know?
- How Much Have You Learned?
- How Do You Apply What You Learned?
- How Well Did You Perform?
- How Do You Extend Your Learning?
- References

To get the most from this Module, you need to do the following:

1. Begin by reading and understanding the Learning Outcome/s and Performance Standards. These tell you what you should know and be able to do at the end of this Module.
2. Find out what you already know by taking the Pretest then check your answer against the Answer Key. If you get 99 to 100% of the items correctly, you may proceed to the next Lesson. This means that you do not need to go through the Lesson because you already know what it is about. If you failed to get 99 to 100% correctly, go through the Lesson again and review especially those items which you failed to get.
3. Do the required Learning Activities. They begin with one or more Information Sheets. An Information Sheet contains important notes or basic information that you need to know.
After reading the Information Sheet, test yourself on how much you learned by answering the Self-check. Refer to the Answer Key for correction. Do not hesitate to go back to the Information Sheet when you do not get all test items correctly. This will ensure your mastery of basic information.
4. Demonstrate what you have learned by doing what the Activity / Operation /Job Sheet directs you to do.
5. You must be able to apply what you have learned in another activity or in real life situation.
6. Accomplish the Scoring Rubrics for you to know how well you performed.

Each Lesson also provides you with references and definition of key terms for your guide. They can be of great help. Use them fully.



If you have questions, ask your teacher for assistance.

LESSON 1

Use Hand Tools



LEARNING OUTCOMES:

At the end of this Lesson, you are expected to do the following:

- LO 1. prepare hand tools;
- LO 2. use appropriate hand tools and test equipment; and
- LO 3. maintain hand tools.



Definition of Terms

Bin - a container or enclosed space for storage.

Computer chassis - the enclosure that contains most of the components of a computer.

Diagnostic tools - used to test the integrity of circuits and the quality of electricity in computer components and to test the functionality of computer ports.

Hazards - risks; dangers.

Insulation - - - - - a material that reduces or prevents the transmission of heat or sound or electricity.

Nozzle - - - - - a projecting part with an opening, as at the end of a hose, for regulating and directing a flow of fluid.

Preventive - intended or used to prevent or hinder.

Static electricity - an accumulation of electric charge on an insulated body.

Tool - - - - - a handheld device that aids in accomplishing a task.

Toolkit - - - - - a set of tools designed to be used together or for a particular purpose.

Acronyms

ESD - - - - - Electrostatic discharge.

USB - - - - - Universal serial bus

LCD - - - - - Liquid crystal display

LEARNING OUTCOME 1

Prepare hand tools

PERFORMANCE STANDARDS

1. Tasks to be undertaken are properly identified.
2. Appropriate hand tools are identified and selected according to the task requirements.
3. Appropriate hand tools checked for proper operation and safety
4. Unsafe or faulty tools are identified
5. Marked all tools for repair according to standard company procedures



Materials

1. Workshop
2. Tables and Chairs
3. Computers
4. USB Flash Drive
5. LCD
6. ESD Tools
7. Hand Tools
8. Cleaning Tools
9. Diagnostic Tools



What Do You Already Know?

Let us determine how much you already know about task preparation and hand tools. Take this test.

Pretest LO 1

A. Direction. Write TRUE if the statement is correct and FALSE if it is wrong. Write your answers on a separate sheet of paper.

- _____ 1. Selecting the best tool for each task requires training in the proper use of the tools, field experience in their safe use, and following the manufacturer's guidance and instructions for that specific tool.
- _____ 2. When obtaining the tool, all the associated tooling and consumable parts, as recommended by the manufacturer, must be included.
- _____ 3. The safe use of a tool depends on using the tool for the purpose for which it was designed and also for other purposes where it can be used as substitute where tool is not available.
- _____ 4. All tools should be kept in good condition with regular maintenance.
- _____ 5. Preparing for a task includes only knowing the task to be done.
- _____ 6. Preparing for a task includes also the sequence of tasks to be done.

B. Direction. Select the letter of the correct answer. Write your answers on a separate sheet of paper.

- 1. Which tool is used for hardware to stand on to prevent static electricity from building up?
 - a. Anti-static mat
 - b. Hex driver
 - c. Philips head screwdriver
 - d. Wire cutter
- 2. Which tool is used to loosen or tighten cross-head screws?
 - a. Anti-static mat
 - b. Hex driver
 - c. Philips head screwdriver
 - d. Wire cutter
- 3. Which tool is sometimes called a nut driver? It is used to tighten nuts in the same way that a screwdriver tightens screws?
 - a. Anti-static mat
 - b. Hex driver
 - c. Philips head screwdriver
 - d. Wire cutter
- 4. Which tool is used to strip and cut wires?
 - a. Anti-static mat
 - b. Hex driver
 - c. Philips head screwdriver
 - d. Wire cutter
- 5. Which tool is used to retrieve parts from location that are too small for your hand to fit?
 - a. Part Retriever
 - b. Lint-free Cloth
 - c. Cable ties
 - d. Flat head screwdriver
- 6. Which tool is used to clean different computer components without scratching or leaving debris?
 - a. Part Retriever
 - c. Cable ties

Safe Use of tools

Once selected, use the tool for the purpose for which it was designed. Not all tools come with detailed instructions, but there are those that do spell out the safety “Do’s and Don’ts” for the your safety. If there are set-up/use options, operator judgment must always be based on what is the safest way to use the tool.

Environmental Safety and Health Program requires the following:

- All tools be kept in good condition with regular maintenance
- The right tool be used for the job
- Each tool be examined before use AND damaged or defective tools NOT to be used
- Tools be operated according to manufacturer’s instructions
- The right protective equipment for the tool and activity be used



HARDWARE TOOLS

To complete hardware repairs, it is important to have a toolkit that should contain all of the necessary tools. As you gain experience, you will learn which tools to have available for different types of jobs. Hardware tools are grouped into these four categories:

- Electro-Static Discharge (ESD) tools
- Hand tools
- Cleaning tools
- Diagnostic tools





Electro-Static Discharge (ESD) Tools



Static electricity is easily generated by friction on carpets, tile flooring, clothing, hair, fabric, and etc. The friction of moving air alone will charge suspended particles and cause the buildup of static electrical charges on people and objects in the environment. Grounded antistatic work mats used with antistatic wrist straps provide the most basic means for the controlled discharge of electrostatic electricity. Examples of ESD Tools:

	Anti-static wrist strap – used to prevent ESD damage to computer equipment.
	Anti-static mat – used to stand on or place hardware on to prevent static electricity from building up.

Hand Tools

A **hand tool** is a device for performing work on a material or a physical system using only hands. The hand tools can be manually used employing force, or electrically powered, using electrical current. Examples of Hand Tools:



	Flat head screwdriver – used to loosen or tighten slotted screws.
	Phillips head screwdriver – used to loosen or tighten cross-head screws.
	Torx screwdriver - used to loosen or tighten screws that have a star-like depression on the top, a feature that is mainly found on laptop.
	Hex driver – sometimes called a nut driver, is used to tighten nuts in the same way that a screwdriver tightens screws.
	Needle-nose plier – used to hold small parts.

	<p>Wire cutter – used to strip and cut wires.</p>
	<p>Tweezers – used to manipulate small parts.</p>
	<p>Part retriever – used to retrieve parts from location that are too small for your hand to fit.</p>
	<p>Flashlight – used to light up areas that you cannot see clearly.</p>

Cleaning Tools



Having the appropriate cleaning tools is essential when maintaining or repairing computers. Using these tools ensures that computer components are not damaged during cleaning. Examples:

	<p>Lint-free cloth – used to clean different computer components without scratching or leaving debris.</p>
---	--

	<p>Compressed air – used to blow away dust and debris from different computer parts without touching the components.</p>
	<p>Cable ties – used to bundle cables neatly inside and outside of a computer.</p>
	<p>Parts organizer – used to hold screw, jumpers, fasteners and other small parts and prevents them from getting mixed together.</p>

Diagnostic Tools

Computers are easier to use and are more dependable with each new generation of hardware and operating system updates, but that doesn't mean that they're problem-free. Here are the most popular tools for diagnosing your computer problems:

	<p>Multimeter – used to test the integrity of circuits and the quality of electricity in computer components.</p>
	<p>Loopback Adapter – used to test the functionality of computer ports.</p>







How Much Have You Learned?

Self-Check 1.1

A. Direction. Write TRUE if the statement is correct and FALSE if it is wrong. Write your answers on a separate sheet of paper.

- _____ 1. Selecting the best tool for each task requires training in the proper use of the tools, field experience in their safe use, and following the manufacturer's guidance and instructions for that specific tool.
- _____ 2. When obtaining the tool, all the associated tooling and consumable parts, as recommended by the manufacturer, must be included.
- _____ 3. The safe use of a tool depends on using the tool for the purpose for which it was designed and also for other purposes where it can be used as substitute where tool is not available.
- _____ 4. All tools should be kept in good condition with regular maintenance.
- _____ 5. Preparing for a task includes only knowing the task to be done.
- _____ 6. Preparing for a task includes also the sequence of tasks to be done.

B. Direction: Identify the tools on the boxes. Write your answer on a separate sheet of paper.

1.		8.	
2.		9.	

3.		10.	
4.		11.	
5.		12.	
6.		13.	
7.		14.	

Refer to the Answer Key. What is your score?



How Do You Apply What You Have Learned?

Show that you learned something by doing this activity.

Activity Sheet 1.1

Direction: Prepare a matrix on Plan Preparation in maintaining and cleaning a personal computer. Some items are already given for you. Continue the Table.

COMPUTER MAINTENANCE

COMPONENTS TO CLEAN	SCHEDULE	Tools to use
Computer case and outside monitor	Daily (sample)	
Keyboard		

Activity Sheet 1.2

Direction: Using the given tools, segregate the following according to its classification.

(The teacher will provide the tools for classification)



How Well Did You Perform?

Find out by accomplishing the Scoring Rubric honestly and sincerely.
Remember it is your learning at stake!

SCORING RUBRICS: for Activity Sheet 1.2

Criteria: Number of Tools classified	Points
20 – 22	10
15 – 19	8
10 – 14	6
5 – 9	4
1 – 4	2

LEARNING OUTCOME 2

Use appropriate hand tools and test equipment

PERFORMANCE STANDARDS

1. Tools are used according to tasks undertaken.
2. All safety procedures in using tools are observed at all times.
3. Malfunctions, unplanned or unusual events are reported to the supervisor.



Materials

1. Workshop
2. Tables and Chairs
3. Computers
4. USB Flash Drive
5. LCD
6. ESD Tools
7. Hand Tools
8. Cleaning Tools
9. Diagnostic Tools



What Do You Already Know?

Let us determine how much you already know about the use of appropriate hand tools and testing equipment. Take this test.

Pretest LO 2

Direction. Fill in the blanks. Write your answers on a separate sheet of paper.

1. The purpose of an antistatic wrist strap is to _____ the electrical charge between you and the equipment.
2. Turn the screwdriver _____ to tighten the screw
3. Turn the screwdriver _____ to loosen the screw.
4. Use a _____ head screwdriver with crosshead screws.
5. On electrical components, an excessive buildup of dust will act like an _____ and trap the heat.
6. When compressed air is used to clean inside the computer, the air should be blown around the components with a minimum distance of _____ inches from the nozzle.
7. Pencils should not be used inside the computer to change the setting of switches or to pry off jumpers because the tip contains _____ which can act as a conductor and may damage the computer components.
8. To clean the screens of CRT monitors, dampen a soft, clean, lint-free cloth with _____ water and wipe the screen from top to bottom.
9. Clean the contacts on components with _____ alcohol.
10. Use a _____ to loosen and tighten bolts that have a hexagonal (six-sided) head.



What Do You Need To Know?

Read the Information Sheet 3.1 very well then find out how much you can remember and how much you learned by doing Self-check 1.1.

Information Sheet 3.1

PROPER USE OF TOOLS

Proper Use of ESD Tools

The purpose of an antistatic wrist strap is to equalize the electrical charge between you and the equipment. The antistatic wrist strap is a conductor that connects your body to the equipment that you are working on. When static electricity builds up in your body, the connection made by the wrist strap to the equipment, or ground, channels the electricity through the wire that connects the strap.



The wrist strap has two parts and is easy to wear:

1. Wrap the strap around your wrist and secure it using the snap or Velcro. The metal on the back of the wrist strap must remain in contact with your skin at all times.
2. Snap the connector at the end of the wire to the wrist strap, and connect the other end either to the equipment or to the same grounding point that the antistatic mat is connected to. The metal skeleton of the case is a good place to connect the wire. When connecting the wire to equipment that you are working on, choose an unpainted metal surface. A painted surface does not conduct the electricity as well as unpainted metal.

An antistatic mat is slightly conductive. It works by drawing static electricity away from a component and transferring it safely from equipment to a grounding point:

1. Lay the mat on the workspace next to or under the computer case.
2. Clip the mat to the case to provide a grounded surface on which you can place parts as you remove them from the system.

Reducing the potential for ESD reduces the likelihood of damage to delicate circuits or components.

Proper Use of Hand Tools

A technician needs to be able to properly use each tool in the toolkit. This topic covers many of the various hand tools used when repairing computers.

Screws

Match each screw with the proper screwdriver. Place the tip of the screwdriver on the head of the screw. Turn the screwdriver clockwise to tighten the screw and counterclockwise to loosen the screw.

Screws can become stripped if you over-tighten them with a screwdriver. A stripped screw, may get stuck in the screw hole, or it may not tighten firmly. Discard stripped screws.

Flat head screwdriver

Use a flat head screwdriver when you are working with a slotted screw. Do not use a flat head screwdriver to remove a Phillips head screw. Never use a screwdriver as a pry bar. If you cannot remove a component, check to see if there is a clip or latch that is securing the component in place.

CAUTION: If excessive force is needed to remove or add a component, something is probably wrong. Take a second look to make sure that you have not missed a screw or a locking clip that is holding the component in place. Refer to the device manual or diagram for additional information.

Phillips head screwdriver

Use a Phillips head screwdriver with crosshead screws. Do not use this type of screwdriver to puncture anything. This will damage the head of the screwdriver.

Hex driver

Use a hex driver to loosen and tighten bolts that have a hexagonal (six-sided) head. Hex bolts should not be over-tightened because the threads of the bolts can be stripped. Do not use a hex driver that is too large for the bolt that you are using.

CAUTION: Some tools are magnetized. When working around electronic devices, be sure that the tools you are using have not been magnetized. Magnetic fields can be harmful to data stored on magnetic media. Test your tool by touching the tool with a screw. If the screw is attracted to the tool, do not use the tool.

Part retriever, Needle-nose pliers, or tweezers

The part retriever, needle-nose pliers, and tweezers can be used to place and retrieve parts that may be hard to reach with your fingers. Do not scratch or hit any components when using these tools.

CAUTION: Pencils should not be used inside the computer to change the setting of switches or to pry off jumpers. The pencil lead can act as a conductor and may damage the computer components.

Proper Use of Cleaning Materials

Keeping computers clean inside and out is a vital part of a maintenance program. Dirt can cause problems with the physical operation of fans, buttons, and other mechanical components. On electrical components, an excessive buildup of dust will act like an insulator and trap the heat. This insulation will impair the ability of heat sinks and cooling fans to keep components cool, causing chips and circuits to overheat and fail.

CAUTION: When compressed air is used to clean inside the computer, the air should be blown around the components with a minimum distance of four inches from the nozzle. The power supply and the fan should be cleaned from the back of the case.

CAUTION: Before cleaning any device, turn it off and unplug the device from the power source.

Computer Cases and Monitors

Clean computer cases and the outside of monitors with a mild cleaning solution on a damp, lint-free cloth. Mix one drop of dishwashing liquid with four ounces of water to create the cleaning solution. If any water drips inside the case, allow enough time for the liquid to dry before powering on the computer.

LCD Screens

Do not use ammoniated glass cleaners or any other solution on an LCD screen, unless the cleaner is specifically designed for the purpose. Harsh chemicals will damage the coating on the screen. There is no glass protecting these screens, so be gentle when cleaning them and do not press firmly on the screen.

CRT Screens

To clean the screens of CRT monitors, dampen a soft, clean, lint-free cloth with distilled water and wipe the screen from top to bottom. Then use a soft, dry cloth to wipe the screen and remove any streaking after you have cleaned the monitor.

Clean dusty components with a can of compressed air. Compressed air does not cause electrostatic buildup on components. Make sure that you are in a well-ventilated area before blowing the dust out of the computer. A best practice is to wear a dust mask to make sure that you do not breathe in the dust particles.



Blow out the dust using short bursts from the can. Never tip the can or use the compressed air can upside down. Do not allow the fan blades to spin from the force of the compressed air. Hold the fan in place. Fan motors can be ruined from spinning when the motor is not turned on.

Component Contacts

Clean the contacts on components with isopropyl alcohol. Do not use rubbing alcohol. Rubbing alcohol contains impurities that can damage contacts. Make sure that the contacts do not collect any lint from the cloth or cotton swab. Blow any lint off the contacts with compressed air before reinstallation.

Keyboard

Clean a desktop keyboard with compressed air or a small, hand-held vacuum cleaner with a brush attachment.

CAUTION: Never use a standard vacuum cleaner inside a computer case. The plastic parts of the vacuum cleaner can build up static electricity and discharge to the components. Use only a vacuum approved for electronic components.

Mouse

Use glass cleaner and a soft cloth to clean the outside of the mouse. Do not spray glass cleaner directly on the mouse. If cleaning a ball mouse, you can remove the ball and clean it with glass cleaner and a soft cloth. Wipe the rollers clean inside the mouse with the same cloth. Do not spray any liquids inside the mouse.



How Much Have You Learned?

Self-Check 2.1

A. Direction. Identify the appropriate tool to use for each of the following:

- _____ 1. Equalize the electrical charge between you and the equipment.
- _____ 2. Tighten / loosen screw
- _____ 3. Tighten / loosen bolt with a hexagonal head
- _____ 4. Retrieve parts that may be hard to reach by your fingers
- _____ 5. Tighten / loosen a slotted screw.

B. Direction: Complete the computer cleaning chart shown below.

COMPUTER MAINTENANCE

COMPONENTS TO CLEAN	CLEAN WITH:
Computer case and outside monitor	Mild cleaning solution and lint free cloth (sample)
Keyboard	
Mouse	
LCD screen	
CRT screen	
Heat sink	
RAM	

Refer to the Answer Key. What is your score?



How Do You Apply What You Have Learned?

Show that you learned something by doing this activity.

Operation Sheet 1.1

Direction: Use the appropriate tools to do each of the following tasks.

1. Loosen computer casing screws
2. Blow away dust from keyboard
3. Tighten screws of a laptop
4. Bundle cables inside the computer
5. Test functionality of the printer port
6. Remove insulation of wires
7. Loosen nuts
8. Prevent from ESD effects



How Well Did You Perform?

Find out by accomplishing the Scoring Rubric honestly and sincerely. Remember it is your learning at stake!

Scoring Rubrics

Task	Was the tool used correct? (please check)		Was the tool used properly? (please check)	
	Yes	No	Yes	No
1. Loosen computer casing screws				
2. Blow away dust from keyboard				
3. Tighten screws of a laptop				
4. Bundle cables inside the computer				
5. Test functionality of the printer port				
6. Remove insulation of wires				
7. Loosen nuts				
8. Prevent from ESD effects				
Total Score				

For Total Score - Number of YES for correct tool used
- Number of Yes for tool used properly

Highest Possible Score 16

Interpretation of score

16	Excellent
14 – 15	Very Good
12 – 13	Good
9 – 11	Fair
8 and below	Poor

LEARNING OUTCOME 3

Maintain hand tools

PERFORMANCE STANDARDS

1. Tools used are according to tasks undertaken.
2. Routine maintenance of tools is undertaken according to standard operational procedures, principles and techniques.
3. Tools are stored safely in appropriate locations in accordance with manufacturer's specifications or standard operating procedures.



Materials

1. Workshop
2. Tables and Chairs
3. Computers
4. USB Flash Drive
5. LCD
6. ESD Tools
7. Hand Tools
8. Cleaning Tools
9. Diagnostic Tools



What Do You Already Know?

Let us determine how much you already know about the maintenance of hand tools. Take this test.

Pretest LO 3

Direction. Write TRUE if the statement is correct and FALSE if it is wrong. Write your answers on a separate sheet of paper.

1. All tools and equipment must be properly maintained so that workers are not endangered.
2. Preventive maintenance is the systematic care and protection of tools, equipment and machines in order to keep them in a safe, usable condition, limit downtime and extend productivity.
3. The degree of detail to include regarding tools and equipment maintenance will depend on the kinds of tools/equipment used.
4. Damaged or defective equipment/tools should be tagged and removed from service.
5. Most manufacturers can provide maintenance schedules for their equipment.
6. Properly stored tools and equipment will be easy to find when needed and are less likely to be lost.
7. Use bins for storing small parts is a good practice on proper storage.
8. Productivity is increased because time is not lost looking for tools, parts and equipment is one of the benefits of proper storage.



What Do You Need To Know?

Read the Information Sheet 1.1 very well then find out how much you can remember and how much you learned by doing Self-check 1.1.

Information Sheet 1.1

TOOL AND EQUIPMENT MAINTENANCE

All tools and equipment must be properly maintained so that workers are not endangered. Regulations require inspections of tools, machines and equipment before use.

Preventive maintenance is the systematic care and protection of tools, equipment and machines in order to keep them in a safe, usable condition limit downtime and extend productivity. We must always be aware that maintenance tasks themselves are potentially hazardous and can result in injury. A successful maintenance program is:

- well organized and scheduled,
- controls hazards,
- defines operational procedures, and
- trains key personnel.

The degree of detail to include regarding tools and equipment maintenance will depend on the kinds of tools/equipment used. Some construction equipment may have very specific inspection and maintenance requirements. Electronic equipment may have different maintenance requirements. Hand tools may require only basic maintenance. Power tools should be maintained in good working order. This may be limited to ensuring that blades/bits are replaced when needed and those guards or other safety devices are operable and any damaged electrical cords/plugs are repaired or replaced. Damaged or defective equipment/tools should be tagged and removed from service.



Most manufacturers can provide maintenance schedules for their equipment. Large companies typically have a comprehensive maintenance program due to the capital investment and/or leasing agreements involved. Smaller companies may lease equipment and maintenance services may be included in the leasing agreement.

General requirements for tools and equipment maintenance include:

- Obtaining a copy of the maintenance schedule recommended by the manufacturer
- Ensuring that maintenance is performed as required
- Ensuring that the person(s) performing the maintenance are competent (e.g. licensed mechanic)
- Retaining records of maintenance/service conducted

- Specifying who is responsible for overseeing equipment maintenance and where the records are kept
- Set up a system for removal and tagging of damaged or defective tools and equipment

PROPER STORAGE OF TOOLS, PARTS, AND EQUIPMENT

To ensure that tools and equipment remain in good condition and last for a long time, store them properly. Properly stored tools and equipment will be easy to find when needed and are less likely to be lost.

Good practices include:

- Parts should be properly stored and labeled (Figure 1).
- Tools should be properly placed on the board, and labeled (Figure 2). Consider drawing the shapes of the tools on the board so that they always get put back in the same position.
- Use bins for storing small parts (Figure 3).
- Consider making an individual (or individuals) responsible for the good maintenance of tools and parts.



Benefits:

- Tools and parts are kept in good condition and are easy to find
- Costs are reduced.
- Productivity is increased because time is not wasted looking for tools, parts and equipment.
- Workshop staff develop a sense of responsibility and pride in their work.



How Much Have You Learned?

Self-Check 1.1

Directions: Enumerate the following.

Good practices in the proper storage of tools: (at least 2)

- 1.
- 2.

Benefits of proper storage of tools: (at least 2)

- 1.
- 2.

Refer to the Answer Key. What is your score?



How Do You Apply What You Have Learned?

Show that you learned something by doing this activity.

Operation Sheet 1.1

Direction: Conduct a maintenance activity on the given hand tools.

TOOLS	MAINTENANCE ACTIVITY
1. Flat Head Screwdriver	Clean and Magnetize
2. Philips Head Screwdriver	Clean and Magnetize
3. Torx Screwdriver	Clean and Magnetize
4. Hex Driver	Clean and Magnetize
5. Needle-Nose Plier	Clean and Lubricate
6. Wire Cutter	Clean, Lubricate and Sharpen, if necessary
7. Tweezer	Clean
8. Part Retriever	Clean
9. Flashlight	Clean and Change batteries if drained
10. Multimeter	Clean and Calibrate



How Well Did You Perform?

Find out by accomplishing the Scoring Rubric honestly and sincerely.
Remember it is your learning at stake!

Score Card

Activity	Excellent	Very satisfactory	Satisfactory	Score
Cleaning hand tools	5	3	1	
Magnetizing hand tools				
Calibrating hand tools				
Changing batteries				
Lubricating hand tools				
Sharpening hand tools				
Storing hand tools				



Congratulations! You did a great job! Rest and relax a while then move on to the next lesson. Good luck!

REFERENCES

LO1

- <http://www.bechtel.com/assets/files/Environmental/ToolboxSafetyTopics/2010/ProperToolSelection.pdf>
- <http://www.iml.uts.edu.au/assessment-futures/designing/assembling.html>

LO 2

- Ron Gilster, **PC Repair Bench Book**, Wiley Publishing Inc., 10475 Crosspoint Boulevard, Indianapolis, IN 46256
- Barry Press, Marcia Press, **PC Upgrade and Repair Bible, Desktop Edition**, Wiley Publishing Inc., 10475 Crosspoint Boulevard, Indianapolis, IN 46256

LO 2

- Ron Gilster, **PC Repair Bench Book**, Wiley Publishing Inc., 10475 Crosspoint Boulevard, Indianapolis, IN 46256
- Barry Press, Marcia Press, **PC Upgrade and Repair Bible, Desktop Edition**, Wiley Publishing Inc., 10475 Crosspoint Boulevard, Indianapolis, IN 46256

LO3

- <http://www.google.com>
- Barry Press, Marcia Press, **PC Upgrade and Repair Bible, Desktop Edition**, Wiley Publishing Inc., 10475 Crosspoint Boulevard, Indianapolis, IN 46256

LESSON 2

Perform Mensuration and Calculation



LEARNING OUTCOMES:

At the end of this Lesson, you are expected to do the following:

- LO 1. select components to be measured; and
- LO 2. carry out mensuration and calculation.



Definition of Terms

Bit - a fundamental unit of information having just two possible values, as either of the binary digits 0 or 1.

Byte - a unit of digital information in computing and telecommunications that most commonly consists of eight bits.

Booting – starting (a computer) by loading an operating system from a disk.

Electronic storage - a device for recording (storing) information (data).

Firewire - Apple Computer's version of a standard, IEEE 1394, High Performance Serial Bus, for connecting devices to your personal computer.

Hot-swappable - the connection and disconnection of peripherals or other components without interrupting system operation.

Interface - the point of interaction or communication between a computer and any other entity, such as a printer or human operator.

Laser - a device that emits light (electromagnetic radiation) through a process of optical amplification based on the stimulated emission of photons.

Magnetic platter - a thin, high precision disk that is coated on both sides with a high precision magnetic material and which is used in a hard disk drive (HDD) to store data.

Memory module - a narrow printed circuit board that holds memory chips.

Magnetic storage media - any storage medium in which different patterns of magnetization are used to represent stored bits or bytes of information

Operating system - a set of programs that manage computer hardware resources and provide common services for application software.

Optical storage media - any storage in which data is written and read with a laser for archival or backup purposes.

Acronyms

HDD – hard disk drive

IDE - Integrated Drive Electronics

LEARNING OUTCOME 1

Select components to be measured

PERFORMANCE STANDARDS

1. Object or component to be measured is identified.
2. Correct specifications are obtained from relevant source.
3. Accurate measurements are obtained for job.



Materials

1. Workshop
2. Tables and Chairs
3. Computers
4. LCD
5. Different types of Memory
6. Different types of Storage Devices
7. Paper
8. Pencil/Ballpen



What Do You Already Know?

Let us determine how much you already know about components in Computer Hardware Servicing to be measured. Take this test.

Pretest LO 1

Direction. Match items on Column A with Column B. Write your answers on a separate sheet of paper.

___ 1. Chips that are located on the motherboard.	A. Registers
___ 2. A magnetic storage device that is installed inside the computer.	B. Flash drive or Thumb drive
___ 3. Early drive controller interface that connects computers and hard disk drives which an interface that uses a 40-pin connector.	C. Read-only memory
___ 4. Temporary storage for data and programs that are being accessed by the CPU.	D. IDE
___ 5. A storage device that uses lasers to read data on the optical media.	E. Floppy drive
___ 6. A storage device that uses removable 3.5-inch disks.	F. Random access memory
___ 7. Soldered the memory chips on a special circuit board.	G. Optical drive
___ 8. A removable storage device that connects to a USB port.	H. DDR
___ 9. Memory cells built right into the CPU that contain specific data needed particularly the Arithmetic and Logic Unit.	I. Hard drive
___ 10. Technology that doubles the maximum bandwidth of SDRAM.	J. Memory module



What Do You Need To Know?

Read the Information Sheet 1.1 very well then find out how much you can remember and how much you learned by doing Self-check 1.1.

Information Sheet 1.1

MEMORY

Although memory is technically any form of electronic storage, it is used most often to identify fast, temporary forms of storage. If your computer's CPU had to constantly access the hard drive to retrieve every piece of data it needs, it would operate very slowly. When the information is kept in memory, the CPU can access it much more quickly. Most forms of memory are intended to store data temporarily.







The CPU accesses memory according to a distinct hierarchy. Whether it comes from permanent storage (the hard drive) or input (the keyboard), most data go into random access memory (RAM) first. The CPU then stores pieces of data it will need to access, often in a cache, and maintains certain special instructions in the register.

Read-only memory (ROM) chips are located in the motherboard. ROM chips contain instructions that can be directly accessed by the CPU. Basic instructions for booting the computer and loading the operating system are stored in ROM. ROM chips retain their contents even when the computer is powered down. The contents cannot be erased or changed by normal means.

Random access memory (RAM) is the temporary storage for data and programs that are being accessed by the CPU. RAM is volatile memory, which means that the contents are erased when the computer is powered off. The more RAM in a computer, the more capacity the computer has to hold and process large programs and files, as well as enhance system performance.

Early computers had RAM installed in the motherboard as individual chips. The individual memory chips, called dual inline package (DIP) chips, were difficult to install and often became loose on the motherboard. To solve this problem, designers soldered the memory chips on a special circuit board called a **memory module**.

Here are some types of memory modules:

	
<p>Dual Inline Package (DIP)</p>	<p>Single Inline Memory Module (SIMM)</p>
	
<p>Dual Inline Memory Module (DIMM)</p>	<p>RAMBus Inline Memory Module (RIMM)</p>
	
<p>Small Outline Dual Inline Memory Module (SODIMM).</p>	

SIMMs have 30-pin and 72-pin configurations. DIMM is a circuit board that holds SDRAM, DDR SDRAM and DDR2 SDRAM.

The speed of memory has a direct impact on how much data a processor can process because faster memory improves the performance of the processor. As processor speed increases, memory speed must also increase. For example, single-channel memory is capable of transferring data at 64 bits. Dual-channel memory increases speed by using a second channel of memory, creating a data transfer rate of 128 bits.

Double Data Rate (DDR) technology doubles the maximum bandwidth of SDRAM. DDR2 offers faster performance while using less energy. DDR3 operates at even higher speeds than DDR2; however, none of these DDR technologies are backward- or forward-compatible.

Even with a wide and fast bus, it still takes longer for data to get from the memory card to the CPU than it takes for the CPU to actually process the data. **Caches** are designed to alleviate this bottleneck by making the data used most often by the CPU instantly available. **Registers** are memory cells built right into the CPU that contain specific data needed by the

CPU, particularly the Arithmetic and Logic Unit (ALU). An integral part of the CPU itself, they are controlled directly by the compiler that sends information for the CPU to process.

STORAGE DRIVES

Storage drives read or write information on magnetic or optical storage media. The drive can be used to store data permanently or to retrieve information from a media disk. Storage drives can be installed inside the computer case, such as a hard drive. For portability, some storage drives can connect to the computer using a USB port, a FireWire port, or an SCSI port. These portable storage drives are sometimes referred to as removable drives and can be used on multiple computers. Here are some common types of storage drives: Floppy drive, Hard drive, Optical drive and Flash drive.

Floppy Drive



A floppy drive, or floppy disk drive, is a storage device that uses removable 3.5-inch floppy disks. These magnetic floppy disks can store 720 KB or 1.44 MB of data. In a computer, the floppy drive is usually configured as the A: drive. The floppy drive



can be used to boot the computer if it contains a bootable floppy disk. A 5.25-inch floppy drive is older technology and is seldom used.

Hard Drive



A hard drive, or hard disk drive, is a magnetic storage device that is installed inside the computer. The hard drive is used as permanent storage for data. In a Windows computer, the hard drive is usually configured as the C: drive and contains the operating system and applications. The hard drive is often configured as the first drive in the boot sequence. The storage capacity of a hard drive is measured in billions of bytes, or gigabytes (GB). The speed of a hard drive is measured in revolutions per minute (RPM). Multiple hard drives can be added to increase storage capacity.

Traditional hard drives are magnetic. Magnetic hard drives have drive motors designed to spin magnetic platters and the drive heads. In contrast, the newer solid state drives (SSDs) do not have moving parts. Because there are no drive motors and moving parts, the SSD uses far less energy than the magnetic hard drive. Non-volatile flash memory chips manage all storage on an SSD, which results in faster access to data, higher reliability, and reduced power usage. SSDs have the same form factor as magnetic hard drives and use ATA or SATA interfaces. SSDs can be installed as a replacement for magnetic drives.

Optical Drive

An optical drive is a storage device that uses lasers to read data on the optical media. There are three types of optical drives: Compact Disc (CD), Digital Versatile Disc (DVD) and Blu-ray Disc (BD).



CD, DVD, and BD media can be pre-recorded (read-only), recordable (write once), or re-writable (read and write multiple times).

External Flash Drive



An external flash drive, also known as a thumb drive, is a removable storage device that connects to a USB port. An external flash drive uses the same type of non-volatile memory chips as solid state drives and does not require power to maintain the data. These drives can be accessed by the operating system in the same way that other types of drives are

accessed.

Types of Drive Interfaces

Hard drives and optical drives are manufactured with different interfaces that are used to connect the drive to the computer. To install a storage drive in a computer, the connection interface on the drive must be the same as the controller on the motherboard. Here are some common drive interfaces:

- IDE – Integrated Drive Electronics, also called Advanced Technology Attachment (ATA) is an early drive controller interface that connects computers and hard disk drives. An IDE interface uses a 40-pin connector.
- SATA – Serial ATA refers to the serial version of the ATA drive controller interface. A SATA interface uses a 7-pin data connector.
- SCSI – Small Computer System Interface is a drive controller interface that can connect up to 15 drives. SCSI can connect both internal and external drives. An SCSI interface uses a 50-pin, 68-pin, or 80-pin connector.



How Much Have You Learned?

Self-Check 1.1

Direction. Match items on Column A with Column B. Write your answers on a separate sheet of paper.

- | | |
|---|-------------------------------|
| _____ 1. A magnetic storage device that is installed inside the computer. | A. Registers |
| _____ 2. Early drive controller interface that connects computers and hard disk drives which an interface that uses a 40-pin connector. | B. Flash drive or Thumb drive |
| _____ 3. Temporary storage for data and programs that are being accessed by the CPU. | C. Read-only memory |
| _____ 4. A storage device that uses lasers to read data on the optical media. | D. IDE |
| _____ 5. A storage device that uses removable 3.5-inch disks. | E. Floppy drive |
| _____ 6. Soldered the memory chips on a special circuit board. | F. Random access memory |
| _____ 7. A removable storage device that connects to a USB port. | G. Optical drive |
| _____ 8. Chips that are located on the motherboard. | H. DDR |
| _____ 9. Memory cells built right into the CPU that contain specific data needed particularly the Arithmetic and Logic Unit. | I. Hard drive |
| _____ 10. Technology that doubles the maximum bandwidth of SDRAM. | J. Memory module |

Refer to the Answer Key. What is your score?



How Do You Apply What You Have Learned?

Show that you learned something by doing this activity.

Operation Sheet 1.1

Direction: Identify what type of memory module is presented.

(The teacher will show several types of memory module.)



How Well Did You Perform?

Count you number of correct answer out of the number of memory modules that your teacher will present.



How Do You Extend Your Learning?

Direction: The teacher will show several types of storage drives and will ask students to identify the type of storage device and its interface is presented.

LEARNING OUTCOME 2

Carry out mensuration and calculation

PERFORMANCE STANDARDS

1. Calculation needed to complete work tasks is performed using the four fundamentals operations (addition, subtractions, multiplication and division).
2. Numerical computation is self-checked and corrected for accuracy.



Materials

1. Workshop
2. Tables and Chairs
3. Computers
4. LCD
5. Different types of Memory
6. Different types of Storage Devices
7. Paper
8. Pencil/Ballpen



What Do You Already Know?

Let us determine how much you already know about carrying out mensuration and calculation. Take this test.

Pretest LO 2

Direction. Perform the following:

- 1) Convert 14 to binary.
- 2) If a 10 KB file is stored in a 1 MB folder, then approximately how many files of the same size can be stored in that folder?

Refer to the Answer Key. What is your score?



What Do You Need To Know?

Read the Information Sheet 2.1 very well then find out how much you can remember and how much you learned by doing Self-check 2.1.

Information Sheet 2.1

DIGITAL REPRESENTATION

Within a computer, information is represented and stored in a digital binary format. The term bit is an abbreviation of binary digit and represents the smallest piece of data. Humans interpret words and pictures; computers interpret only patterns of bits.

A bit can have only two possible values, a one digit (1) or a zero digit (0). A bit can be used to represent the state of something that has two states. For example, a light switch can be either On or Off; in binary representation, these states would correspond to 1 and 0, respectively.



Computers use binary codes to represent and interpret letters, numbers and special characters with bits. A commonly used code is the American Standard Code for Information

Interchange (ASCII). With ASCII, each character is represented by a string of bits. For example:

Capital letter: A = 01000001

Number: 9 = 00001001

Special character: # = 00100011

Each group of eight bits, such as the representations of letters and numbers, is known as a byte. Codes can be used to represent almost any type of information digitally: computer data, graphics, photos, voice, video, and music.

CONVERT DECIMAL NUMBERS TO BINARY

To convert a decimal number to binary, all you have to do is divide the number by 2. Get the quotient and the remainder. Bring down the quotient, divide it by 2, and get the quotient and remainder again. Do it repeatedly until the quotient results to 0. Copy the remainder from bottom to top, and that is the binary equivalent.

Example: 25

	Quotient	Remainder	
25/2	12	1	↑
12/2	6	0	
6/2	3	0	
3/2	1	1	
1/2	0	1	

25 = 11001

Checking: 1 1 0 0 1 multiplier
 16 8 4 2 1 equivalents
 16 8 0 0 1 results
 16+8+1 = 25

CALCULATING DATA STORAGE

While a bit is the smallest representation of data, the most basic unit of digital storage is the byte. A byte is 8 bits and is the smallest unit of measure (UOM) used to represent data storage capacity.

When referring to storage space, we use the terms bytes (B), kilobytes (KB), megabytes (MB), gigabytes (GB), and terabytes (TB).

One kilobyte is a little more than one thousand bytes, specifically 1,024. A megabyte represents more than a million bytes or 1,048,576. A gigabyte is 1,073,741,824 bytes. A terabyte is 1,099,511,627,776. The exact number is gained by taking 2ⁿ power.

Quantities of bytes						
Common prefix				Binary prefix		
Name	Symbol	Decimal	Binary	Name	Symbol	Binary
		SI	JEDEC			IEC
kilobyte	KB/kB	10 ³	2 ¹⁰	kibibyte	KiB	2 ¹⁰
megabyte	MB	10 ⁶	2 ²⁰	mebibyte	MiB	2 ²⁰
gigabyte	GB	10 ⁹	2 ³⁰	gibibyte	GiB	2 ³⁰
terabyte	TB	10 ¹²	2 ⁴⁰	tebibyte	TiB	2 ⁴⁰
petabyte	PB	10 ¹⁵	2 ⁵⁰	pebibyte	PiB	2 ⁵⁰
exabyte	EB	10 ¹⁸	2 ⁶⁰	exbibyte	EiB	2 ⁶⁰
zettabyte	ZB	10 ²¹	2 ⁷⁰	zebibyte	ZiB	2 ⁷⁰
yottabyte	YB	10 ²⁴	2 ⁸⁰	yobibyte	YiB	2 ⁸⁰

In general, when something is represented digitally, the greater the detail, the greater the number of bits needed to represent it. A low-resolution picture from a digital camera will use around 360KB, and a high-resolution picture could use 2 MB or more.

Kilobytes, megabytes, gigabytes, and terabytes are typically used to measure the size or storage capacity of a device. Examples of components and devices that use byte storage include: random access memory (RAM), hard disk drive space, CDs, DVDs, and MP3 players.

CDs have a data storage capacity of approximately 700 MB. DVDs have a data storage capacity of approximately 4.3 GB on a single-layer disc, and approximately 8.5 GB on a dual-layer disc. BDs have a storage capacity of 25 GB on a single-layer disc, and 50 GB on a dual-layer disc.

Once we know the size of a file or folder, it is possible to determine the number of bytes being used. For example:

A file is 20 KB in size

1 KB = 1,024 Bytes

20 * 1,024 = 20,480 bytes in a 20 KB file

If a 20 KB file is stored in a 1 MB folder (1 MB = 1,048,576 bytes of space); then approximately a total of 51 files of the same size can be stored in that folder (1,048,576 / 20,480 = 51.2).



How Much Have You Learned?

Self-Check 2.1

Direction: Convert the decimal numbers shown below to binary. Perform checking to verify answers.

1) 19

2) 28

3) 37

Refer to the Answer Key. What is your score?



How Do You Apply What You Have Learned?

Show that you learned something by doing this activity.

Operation Sheet 2.1

Direction: Solve the problems indicated below. Show your solution.

1. How many 60 KB jpg files can be stored on a 2 MB folder in your hard drive?
2. How many 5 MB mp3 files can be stored on a 1 GB flash drive?
3. How many 750 MB avi files can be stored on a 4.3 GB DVD-R?



How Well Did You Perform?

Find out by accomplishing the Scoring Rubric honestly and sincerely.
Remember it is your learning at stake!

Interpretation of Scores

3 – Excellent

2 – Good

1 – Fair

0 – Poor



**Congratulations! You did a great job!
Rest and relax a while then move on to
the next lesson. Good luck!**

REFERENCES

LO1

- Ron Gilster, **PC Repair Bench Book.**, Wiley Publishing Inc., 10475 Crosspoint Boulevard, Indianapolis, IN 46256
- Barry Press, Marcia Press, **PC Upgrade and Repair Bible, Desktop Edition.**, Wiley Publishing Inc., 10475 Crosspoint Boulevard, Indianapolis, IN 46256
- en.wikipedia.org

LO 2

- Ron Gilster, **PC Repair Bench Book.**, Wiley Publishing Inc., 10475 Crosspoint Boulevard, Indianapolis, IN 46256
- Barry Press, Marcia Press, **PC Upgrade and Repair Bible, Desktop Edition.**, Wiley Publishing Inc., 10475 Crosspoint Boulevard, Indianapolis, IN 46256
- en.wikipedia.org

LESSON 3

Prepare and Interpret Technical Drawing



LEARNING OUTCOMES:

At the end of this Lesson, you are expected to do the following:

- LO 1. identify different kinds of technical drawing; and**
- LO 2. interpret technical drawing.**



Definition of Terms

Drawing	act or the art of representing any object by means of lines and shades
Picture	visual representation or image painted, drawn, photographed, or otherwise rendered on a flat surface
process	a series of actions, changes, or functions bringing about a result
Technical	pertaining to the useful or mechanical arts, or to science or business
Technician	a person skilled in mechanical or industrial techniques or in a particular technical field
Flowchart	a diagram that uses graphic symbols to depict the nature and flow of the steps in a process
Tool kit	a small bag or box equipped with hand tools
Tree structure	an algorithm for placing and locating files in an organized database
Video display terminal	a computer terminal having a video display that uses a cathode-ray tube.

Acronym

VDT – Video Display Terminal

LEARNING OUTCOME 1

Identify different kinds of technical drawing

PERFORMANCE STANDARDS

1. Correct technical drawing is selected according to job requirements.
2. Technical drawings are segregated in accordance with the types and kinds of drawings.
3. Components, assemblies or objects are recognized as required.



Materials

1. Workshop
2. Tables and Chairs
3. Computers
4. USB Flash Drive
5. LCD
6. Drawing Tools



What Do You Already Know?

Let us determine how much you already know about one kind of technical drawing. Take this test.

Pretest LO 1

A. **Directions:** Match Column A with Column B. Write only the letter of the correct answer on a separate sheet of paper.

Column B

Column A

- | | |
|---|----------------|
| 1. It is represented by a rectangle. It refers to an action in a business process. | a. Decision |
| 2. It is represented by a diamond. A process that can answer a decision of "yes" or "no" requires a decision box. | b. Process |
| 3. It is represented by a small circle or a connector box and is labeled using letters. | c. Arrow line |
| 4. Drawn in one direction, preferably from top to bottom to keep a flowchart clear. | d. Connector |
| 5. A process is represented by a rectangle with double lines on each side. | e. Sub-process |



What Do You Need To Know?

Read Information Sheet 1.1 very well then find out how much you can remember and how much you learned by doing Self-check 1.1.

Information Sheet 1.1

Flowchart

A flowchart is a diagram that uses graphic symbols to depict the nature and flow of the steps in a process. Another name for this tool is "flow diagram."

What Are the Elements of a Flowchart?

A flowchart is commonly used by systems analysts to visualize the series of processes in a business system. A flowchart is a useful tool to design an efficient business system and to troubleshoot or improve an existing system. A flowchart consists of elements, such as the terminator, process, sub process, decision, arrow lines, and connectors.

1. Terminator

A terminator is represented by a small rectangle with curved corners. A terminator appears at the start and at the end of a flowchart. The end terminator appears only once on a single flowchart.

2. Process

A process is represented by a rectangle. It refers to an action in a business process. It must be described clearly and concisely. A process can be described using a single verb-noun phrase; for example, "Order Office Supplies." The same level of detail must be kept in processes on a single flowchart.

3. Sub-process

A sub-process is represented by a rectangle with double lines on each side. A sub-process is a major process that could be broken up into simpler processes developed into another flowchart.

4. Decision

A decision is represented by a diamond. A process that can answer a decision of "yes" or "no" requires a decision box.

5. Connector

A connector is represented by a small circle or a connector box and is labeled using letters. A flowchart written on a single page is clearer than a flowchart on several pages. A connector ensures that the processes are connected logically and correctly on several pages.

6. Arrow Lines

Arrow lines drawn in one direction, preferably from top to bottom, keep a flowchart clear. Avoid arrow lines that loop because this could indicate redundancy in the business process.

When should teams use flowcharts?

At the beginning of your process improvement efforts, an *as-is* flowchart helps your team and others involved in the process to understand how it currently works. The team may find it helpful to compare this *as-is* flowchart with a diagram of the way the process is *supposed* to work. Later, the team will develop a flowchart of the modified process again, to record how it actually functions. At some point, your team may want to create an *ideal* flowchart to show how you would ultimately like the process to be performed.

Benefits of Using Flowcharts

1. Promote understanding of a process.

People may have differing ideas about how a process works. A flowchart can help you gain agreement about the sequence of steps. Flowcharts promote understanding in a way that written procedures cannot do. One good flowchart can replace pages of words.

2. Provide a tool for training employees.

Because of the way they visually lay out the sequence of process steps, flowcharts can be very helpful in training employees to perform the process according to standardized procedures.

3. Identify problem areas and opportunities for process improvement.

Once you break down the process steps and diagram them, problem areas become more visible. It is easy to spot opportunities for simplifying and refining your process by analyzing decision points, redundant steps, and rework loops.

Basic Flowchart Symbols

The **symbols** that are commonly used in flowcharts (Viewgraph 3) have **specific meanings** and are **connected by arrows indicating the flow** from one step to another:

1. **Oval.** Ovals indicate both the starting point and the ending point of the process steps.



2. **Box.** A box represents an individual step or activity in the process.



3. **Diamond.** A diamond shows a decision point, such as *yes/no* or *go/no-go*. Each path emerging from the diamond must be labeled with one of the possible answers.

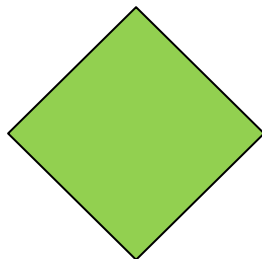

4. **Circle.** A circle indicates that a particular step is connected to another page or part of the Flowchart. A letter placed in the circle clarifies the continuation.

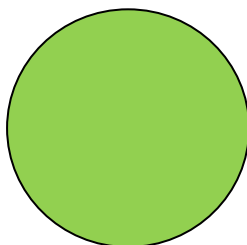

5. **Triangle.** A triangle shows where an in-process measurement occurs.

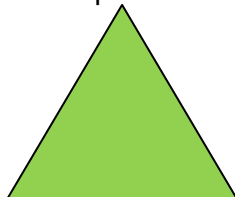
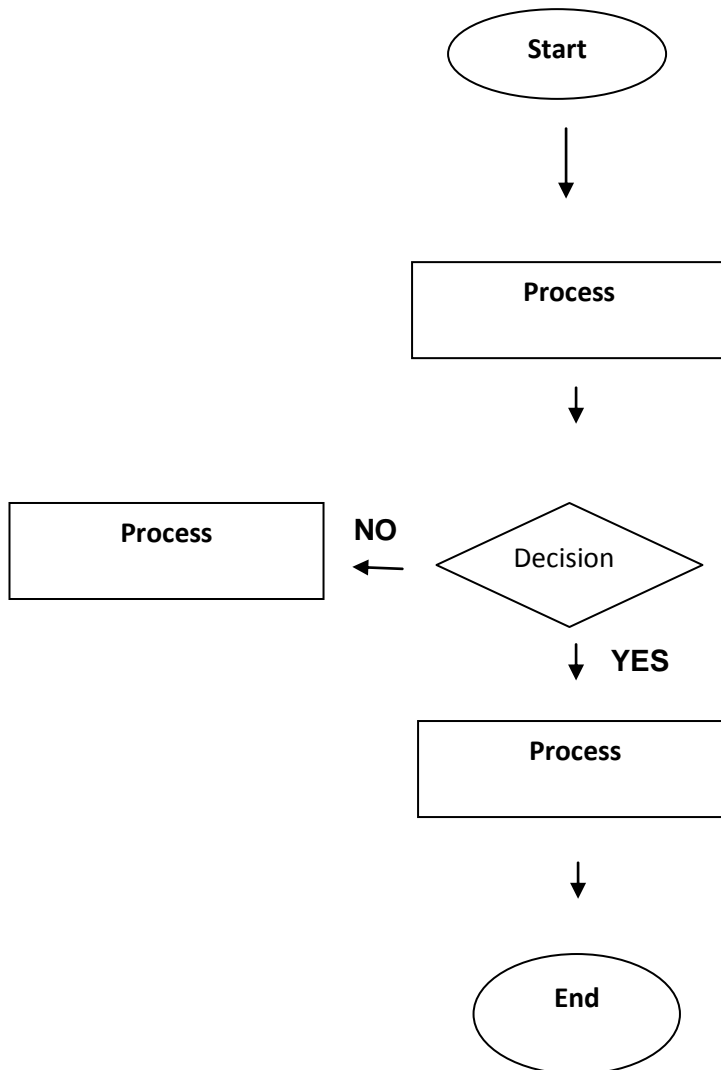

Fig 1. Example of a Simple Flowchart





How Much Have You Learned?



Self-Check 1.1

A. Directions: Match Column A with Column B. Write only the letter of the correct answer on a separate sheet of paper.

Column A

1. Indicates that a particular step is connected to another page or part of the flowchart
2. Shows a decision point, such as *yes/no* or *go/no-go*.
3. Indicates both the starting point and the ending point of the process steps
4. Shows where an in-process measurement occurs
5. Represents an individual step or activity in the process

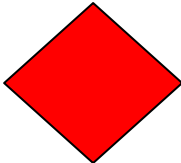
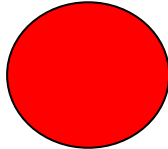
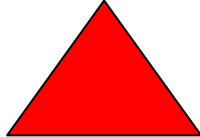
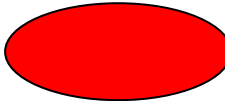
Column B

- a. 
- b. 
- c. 
- d. 
- e. 
- f. 

Refer to the Answer Key. What is your score?



How Do You Apply What You Have Learned?

Show that you learned something by doing this activity.

Operation Sheet 1.1

Directions: Using the basic symbols used for flowchart, make your own simple flow chart to illustrate the process of cleaning the computer parts and peripherals properly. Include the given activities below.

1. Preparation of cleaning tools
2. Identifying the parts to be cleaned
3. Cleaning the different peripherals



How Well Did You Perform?

Find out by accomplishing the Scoring Rubric honestly and sincerely.
Remember it is your learning at stake!

Scoring Rubrics

Preparation of Flowcharts	4	3	2	1
Drawing	All assigned details and elements have been added. The details are clear and easy to identify.	Almost all assigned details / elements (at least 85%) have been added. The details are clear and easy to identify.	Almost all assigned details and elements (at least 85%) have been added. A few details are difficult to identify.	Fewer than 85% of the assigned details and elements are present OR most details are difficult to identify.

LEARNING OUTCOME 2

Interpret technical drawing

PERFORMANCE STANDARDS

1. Dimensions of the key features of the objects are depicted in the drawing correctly identified.
2. Symbols used in the drawing are identified and interpreted correctly.
3. Drawing is checked and validated against job requirements or equipment in accordance with standard operating procedures.



Materials

1. Workshop
2. Tables and Chairs
3. Computers
4. USB Flash Drive
5. LCD
6. Drawing Tools



What Do You Already Know?

Let us determine how much you already know about interpreting of technical drawing. Take this test.

Pretest LO 2

Directions: Interpret the flowchart.

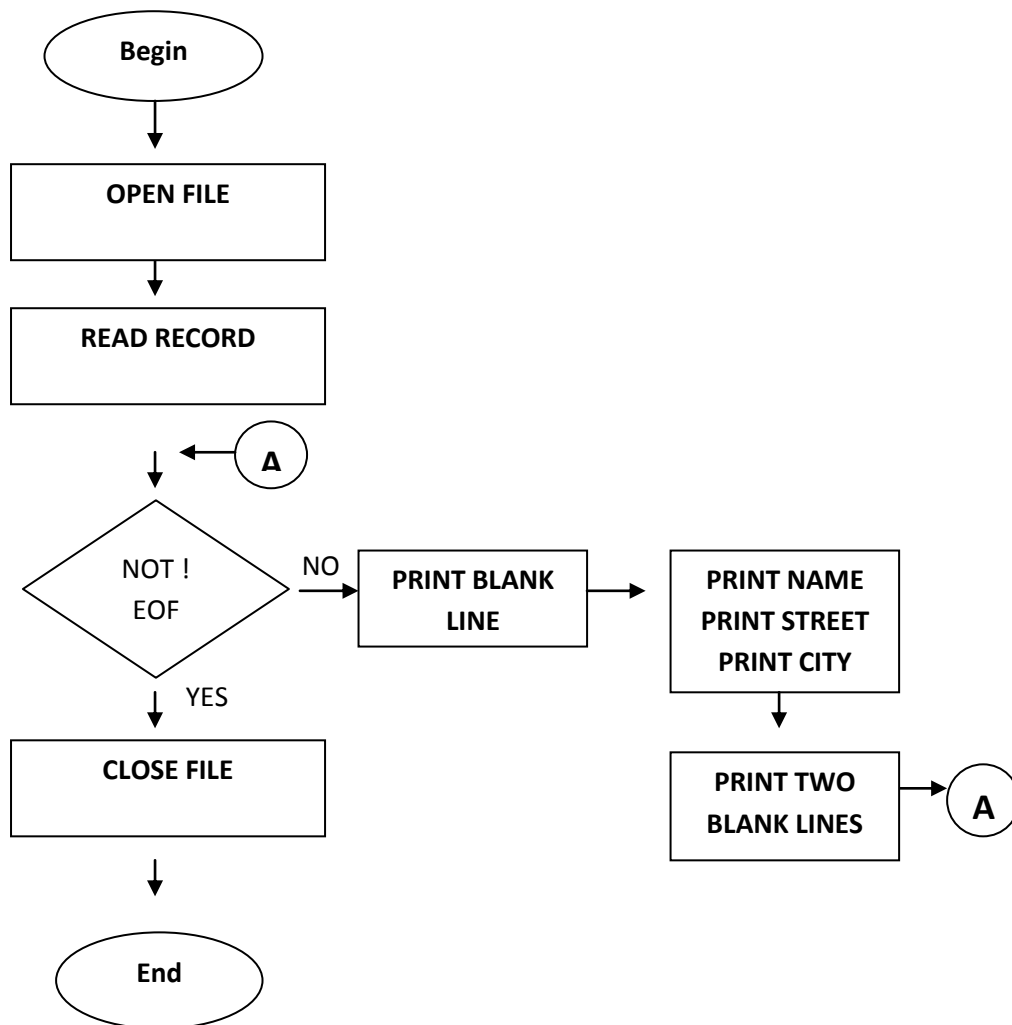



What Do You Need To Know?

Read the Information Sheet 2.1 very well then find out how much you can remember and how much you learned by doing Self-check 2.1.

Information Sheet 2.1

How do you interpret flowcharts?

A Flowchart will help you understand your process and uncover ways to improve it only if you use it to analyze what is happening. Interpreting your Flowchart will help

you to :

- ✓ **Determine who is involved** in the process.
- ✓ **Form theories about root causes.**
- ✓ **Identify ways to streamline** the process.
- ✓ **Determine how to implement changes** to the process.
- ✓ **Locate cost-added-only steps.**
- ✓ **Provide training** on how the process works or should work.

Below is a sequence of steps that will help you through an orderly analysis of your flowchart.

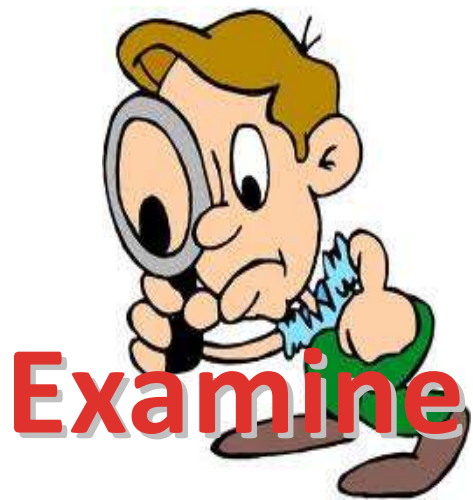

Step 1 - Examine each process step for the following conditions that indicate a need to improve the process:

Bottlenecks. These points in the process where it slows down may be caused by redundant or unnecessary steps, rework, lack of capacity, or other factors.

Weak links. These are steps where problems occur because of inadequate training of process workers, equipment that needs to be repaired or replaced, or insufficient technical documentation. "Inform the drill leader and improvise" is one of the weak links.

Poorly defined steps. Steps which are not well-defined may be interpreted and performed in a different way by each person involved, leading to process variation. "Improvise" is a poorly defined step in the weak link cited above.

Step 2 - Examine each decision symbol. You may want to collect data on how often there is a "yes" or "no" answer at decision points marked by a diamond shaped symbol. If most decisions go one way rather than the other, you may be able to remove this decision point.

Step 3 - Examine each rework loop. Processes with numerous checks generate rework and waste. Examine the activities preceding the rework loop and identify those that need to be improved. Look for ways to shorten or eliminate the loop.

Step 4 - Examine each activity symbol. Does the step help build a *key quality characteristic* into the end product? If not, consider eliminating it.

Types of flowchart

Besides the three *levels of detail* used to categorize Flowcharts, there are *three main types* of flowcharts namely , **linear, deployment, and opportunity**. The level of detail can be depicted as macro, mini, or micro for each of these types.

1. **Linear Flowchart.** A linear flowchart is a diagram that displays the sequence of work steps that make up a process. This tool can help identify rework and redundant or unnecessary steps within a process.
2. **Deployment Flowchart.** A deployment flowchart shows the actual process flow and identifies the people or groups involved at each step. Horizontal lines define customer-supplier relationships. This type of chart shows where the people or groups fit into the process sequence, and how they relate to one another throughout the process.

How do we construct a linear flowchart?

Following are the seven steps for developing a linear flowchart

1. **Define the process to be flowcharted**, and the purpose for flowcharting it.
2. **Assemble the right people** to develop the flowchart—those operators, technicians, or office workers who are actually involved in the process.
3. **Establish process boundaries**—the starting and ending points.
 - Identify the major activities or sub processes that are included in the process.
 - Determine what is *not included* in the scope of the process to remove any doubt or confusion about the boundaries. This may also help establish the scope of related processes.
4. **List the steps, activities, and decisions** to be charted. If your team is not sure about a step, mark it to be investigated later.
5. **Put the steps in chronological sequence.** Sometimes it's easier to start with the last step and work back to the first step.
6. **Assign flowchart symbols** such as boxes, diamonds, and triangles.
7. **Review and title** the Flowchart.



How Much Have You Learned?

Self-Check 2.1

Directions : Arrange the following steps in developing a flowchart . Put the number on a separate sheet of paper.

- _____ Define the process to be flowcharted, and the purpose for flowcharting it.
- _____ Establish process boundaries - the starting and ending points.
- _____ Put the steps in chronological sequence. Sometimes it's easier to start with the last step and work back to the first step.
- _____ Assign flowchart symbols such as boxes, diamonds, and triangles.
- _____ Review and title the flowchart.
- _____ Assemble the right people to develop the flowchart— those operators, technicians, or office workers who are actually involved in the process.
- _____ List the steps, activities, and decisions to be charted. If your team is not sure about a step, mark it to be investigated later.

Refer to the Answer Key. What is your score?



How Do You Apply What You Have Learned?

Show that you learned something by doing this activity.

Operation Sheet 2.1

Directions: Analyze carefully the given task below: Work in a group (5 members each) and develop a flowchart based on the given situation below.

Your task:

You are a member of a product assembly team in a gaming machine manufacturer and are looking for ways of building the product more efficiently. You are asked to break down the assembly process into a set of flowcharts, showing how sub-assemblies are made and then built into the final product. Present your developed flowchart to the team leader.



How Well Did You Perform?

**Find out by accomplishing the Scoring Rubric honestly and sincerely.
Remember it is your learning at stake!**

Scoring Rubrics:

You will be graded according to:

1. Clarity of your flowchart
2. Completeness
3. Accuracy
4. presentation

Criteria	Points	Your Score
1. Clarity	25	
2. Completeness	25	
3. Accuracy	25	
4. Class presentation of your chart	25	
Total	100	

Interpretation of Scores

97 – 100	Excellent
86 – 96	Very Good
75 – 85	Good
51 – 75	Fair
50 and below	Poor



**Congratulations! You did a great job!
Rest and relax a while then move on to
the next lesson. Good luck!**

REFERENCES

LO1

- <http://machineshop.olin.edu/resources/documents/Technical%20Drawing%20-%20Class%20Handout.pdf>
- www.breezetreel.com/
- www.patton-patton.com/basic_flow_chart_sy.<http://www.lakeland>
- www.tesda.gov.ph

LO 2

- www.edrawsoft.com/flowchart.php
- <http://www.eod.gvsu.edu/~blaucha/c2d2/Structured%20Design%20Using%20Flowcharts.pdf>

LO 3

- <http://library.thinkquest.org/TQ0312380/machine.htm>
- <http://www.agmachine.com/xmmd43d.htm>

LESSON 4

Practice Occupational Safety and Health

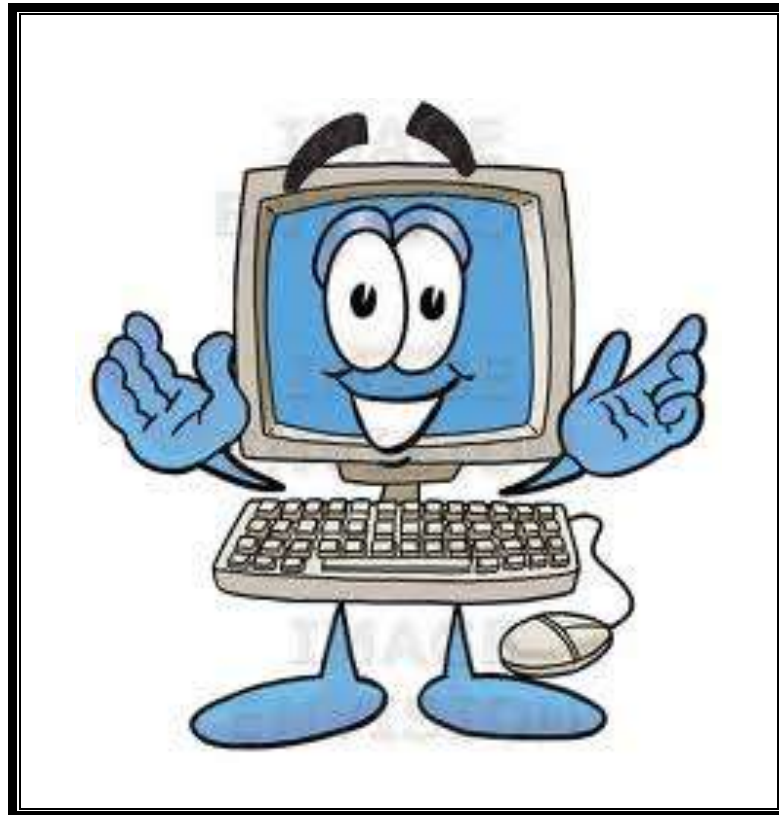

LEARNING OUTCOMES:

At the end of this Lesson, you are expected to do the following:

- LO 1. identify hazards and risk ;**
- LO 2. evaluate hazards and risk ; and**
- LO 3. control hazards and risk.**



Definition of Terms

Chemical hazard	Any hazard that results from the accidental exposure to toxic chemical.
Desktop computer	Is a personal computer (PC) in a form intended for stationary use.
Electric shock	Characterized by pain and muscular spasm caused by an electric current.
Elimination	The process of removing the hazard from the workplace.
Ergonomics	The science of designing the workplace environment to fit the user.
Hazard	A situation that has the potential to harm the health and safety of people.
Hazard control	The development of systems to prevent accidents or injuries.
Health	The general condition of a person in all aspects.
Housekeeping	Is the systematic process of making a home neat and clean and in order.
Risk	A potential hazardous condition that a chosen action or activity causes.
Risk management	The process of analyzing exposure to risk and managing it.
Safety	The state of being "safe".
Standards	Something accepted as a basis for comparison.
Tree structure	An algorithm for placing and locating files in an organized database.

Acronyms

OSH	Occupational safety and health
PPE	Personal protective equipment

LEARNING OUTCOME 1

Identify hazards and risk

PERFORMANCE STANDARDS

1. Workplace hazards and risks are identified and clearly explained.
2. Hazards/risks and their corresponding indicators are identified in accordance with the company procedures.
3. Contingency measures are recognized and established in accordance with organizational procedures.



Materials

1. Workplace
2. Personal protective equipment (PPE)
3. Learning guides
4. Hand-outs
 - Organizational safety and health protocol
 - 5S
 - Hazards/risk identification and control
5. CD's, VHS tapes, transparencies



What Do You Already Know?

Let us determine how much you already know about hazards and risks. Take this test.

Pretest LO 1

A. Directions: Identify the type of hazards. Match Column A with Column B. Write only the letter of each correct answer on a separate sheet of paper.

Column A

1. cables running across the floor
2. hot components or sharp edges of computers
3. inkjet printer cartridge
4. exposed power cable
5. open casing of computer monitor

Column B

1. mechanical hazard
2. physical hazard
3. electric shock hazards
4. chemical hazard
5. CRT monitor high voltage hazard

B. Identify the 5S principles and give (1) example for each principle.

1. _____

Example : _____

2. _____

Example : _____

3. _____

Example : _____

4. _____

Example : _____

5. _____

Example : _____



What Do You Need To Know?

Read Information Sheet 1.1 very well then find out how much you can remember and how much you learned by doing Self-check 1.1.

Information Sheet 1.1

Hazard Identification, Risk Assessment, and Risk Control

Occupational safety and health (OSH) is a planned system of working to prevent illness and injury where you work by recognizing and identifying hazards and risks. Health and safety procedure is the responsibility of all people in the computer and technology industries. You must identify the hazards where you are working and decide how dangerous they are. Eliminate the hazard or modify the risk that it presents. This Module is intended to give you some guidelines and advice on common areas of health and safety problems in the computer industry and to help you gain a general awareness of your responsibilities as user and technician in a safe environment.

There are three steps used to manage health and safety at work:

1. Spot the Hazard (Hazard Identification)
2. Assess the Risk (Risk Assessment)
3. Make the Changes (Risk Control)

At work you can use these three Think Safe steps to help prevent accidents.

Using the Think Safe Steps

1. Spot the Hazard

Key Point

A hazard is anything that could hurt you or someone else.

Examples of workplace hazards include:

- frayed electrical cords (could result in electrical shock)
- boxes stacked precariously (they could fall on someone)
- noisy machinery (could result in damage to your hearing)



During work experience, you must remain alert to anything that may be dangerous. If you see, hear or smell anything odd, take note. If you think it could be a hazard, tell someone.

2. Assess the Risk

Key Point

Assessing the risk means working out how likely it is that a hazard will harm someone and how serious the harm could be.

Whenever you spot a hazard, assess the risk by asking yourself two questions:

- How likely is it that the hazard could harm me or someone else?
- How badly could I or someone else be harmed?

Always tell someone (your employer, your supervisor or your health and safety representative) about hazards you can't fix yourself, especially if the hazard could cause serious harm to anyone.

For example:

- Ask your supervisor for instructions and training before using equipment.
- Ask for help moving or lifting heavy objects.
- Tell your supervisor if you think a work practice could be dangerous.

If you are not sure of the safest way to do something during work experience, always ask your work experience supervisor.

3. Make the Changes

Key Point

It is your employer's responsibility to fix hazards. Sometimes you may be able to fix simple hazards yourself, as long as you don't put yourself or others at risk. For example, you can pick up things from the floor and put them away to eliminate a trip hazard.

Common hazards encountered by computer technicians and users

A hazard is a situation in the workplace that has the potential to harm the health and safety of people or to damage plant and equipment. The situation could involve a task, chemical or equipment used. Hazard management is a continuous process that can be used to improve the health and safety of all workplaces.

Physical Hazards

One of the most common physical hazards involving computer technicians is cables running across the floor. If someone trips, falls, and hurts himself because of a cable you ran across the floor, someone (you, your employer, or your customer) has a serious legal negligence problem. If



you need to temporarily run a cable across the floor, place a *Danger* sign similar to those "wet floor" signs used by cleaning services.

For cables that are temporary but will need to run across the floor for a longer period of time, use "gaffers tape". Gaffers tape is a heavy tape with strong adhesive to stick to the floor. It comes in a wide range of colors, from unintrusive matte black to hazard warning red. Although it has strong adhesive, it can be removed easily and cleanly.

For long term cable routing there is a wide variety of cable organizing devices like cable ties, cable wraps, and cable raceways which can be used to run cable safely along the wall or ceiling.

Other common physical hazards include leaving tools on top of ladders and placing electronic equipment in precarious positions or on support that is not sturdy enough or not designed for holding electronic equipment.

Mechanical Hazards

When working on electronic equipment, ask yourself "Is there any way this equipment could hurt me?". You might stick your hand in a printer and suddenly the paper feed arm moves, feeding not only paper through the printer, but a piece of your finger too.



You might move your hand past a computer chassis and lose a chunk of flesh because it is razor sharp. When working on electronic equipment always be alert to any possibility of being hurt by moving parts, hot components, or sharp edges.

Chemical Hazards



There is a wide array of chemicals used with electronic equipment. There are display cleaning chemicals, keyboard cleaning chemicals, compressed gas dirt and dust removers, and many cleaning solvents. Some of these chemicals can be harmful if accidentally swallowed, get on bare skin, or get in eyes. Before using any chemicals for electronic equipment always read the warnings and instructions on the label.

Also be very careful when dealing with inkjet printer cartridges, or laser printer toner cartridges. Ink and toner can stain skin, clothing, and carpet.

Electric Shock Hazard

Inside computers and electronic equipment, there is a range of voltages from 3.3 volts to 25 volts, most of these are harmless. But at the power supply, you'll find line voltage, which is a lethal 220 volts.



Most of the time while working inside computers and electronic equipment, you'll want them unplugged from the wall socket. If you need to work on equipment while it is still plugged in or powered up, remove all jewelry and wrist watches.

If you must work inside a line power distribution box, wear an electrician's rubber insulated gloves and safety glasses. You might think you don't need these safety devices because you are going to be extra careful, but one little slip could cause a flaming explosion that could take off your hand, embed shrapnel in your eyes, or conduct electricity through your heart, where it takes only 10 milliamps (0.01) to kill a human.

- **CRT Monitor High-Voltage Hazard**

CRT monitors are becoming less common nowadays, but should you run into one, it is best NOT to open it up. Instead, outsource any CRT repair job to a qualified CRT repair service. A CRT monitor has a high-voltage anode inside it, which can carry a charge of up to 25,000 volts, and it can still be holding a high charge days after the power is removed.

If you must open a CRT monitor case for some reason, be sure to study the proper way to discharge a CRT before you proceed. It involves using a jumper wire and a flat blade screwdriver to shorten the anode to ground. After being discharged, even with no power connection, the anode voltage will actually build up again. So you have to repeatedly discharge it.



 **How Much Have You Learned?**

Self-Check 1.1

A. Direction: Read carefully each statement below. Place T on the line if the statement is **TRUE**. Place **F** if the statement is **FALSE**.

- _____ 1. Health and safety procedure is the responsibility of all persons in the computer and technology industries.
- _____ 2. Spotting the hazards means working out how likely it is that a hazard will harm someone and how serious the harm could be.
- _____ 3. If you need to temporarily run a cable across the floor, place a *Danger* sign similar to those "wet floor" signs used by cleaning services.
- _____ 4. An LCD monitor has a high-voltage anode inside it, which can carry a charge of up to 25,000 volts, and it can still be holding a high charge days after the power is removed.
- _____ 5. Inkjet printer cartridges, or laser printer toner cartridges are hazardous to users.

B. Direction : Identify what hazard is being illustrated in the situation below .

- _____ 1. Slippery computer laboratory floor
- _____ 2. Hot components, or sharp edges of computer devices
- _____ 3. Laser printer toner
- _____ 4. Obstructed electrical cables
- _____ 5. Open CRT monitor

Refer to the Answer Key. What is your score?



How Do You Apply What You Have Learned?

Show that you learned something by doing this activity.

Operation Sheet 1.1

A. Direction: Analyze the given task below and answer the worksheet that follows.

Task:

1. Choose an industry or type of workplace e.g. computer laboratory, computer manufacturing, or a computer shop.
2. Make a list of hazards that may be present in that workplace e.g. slippery floors from spilt water, oil etc; uneven floors from changing floor level. Use the Table below.
3. Describe the risks.
4. Write down ways to control the risks.

Spot the Hazard	Assess the Risk
A Hazard is anything that could hurt you or someone else	Work out how likely it is that the hazard will hurt someone and how badly he/she could be hurt
List the hazards	Describe the risks
<ul style="list-style-type: none"> • • • • • • • • • • 	<ul style="list-style-type: none"> • • • • • • • • • •

B. Direction: Observe the set-up of your school's Computer Laboratory. Observe the procedures and arrangement being practiced and used in the workplace. Identify hazards and assess the risk based on your observations.

I Care for Safe Work Short Answer

Spot the hazard

If you spot something hazardous, what should you do?

- Simple hazard (e.g. boxes on the floor in the way)

- More complex hazard (e.g. frayed cords, damaged equipment)

Assess the risk

What two main things should the person in charge or responsible for safety consider when assessing the risk?



How Well Did You Perform?

**Find out by accomplishing the Scoring Rubric honestly and sincerely.
Remember it is your learning at stake!**

Scoring Rubrics

Criteria	4	3	2	1
1. Number of hazards	4 hazards or more	3 hazards	2 hazards	1 hazard
2. Description of Risks	Hazards completely and accurately assessed	All hazards completely and accurately but not clearly	All hazards completely described but not accurately and clearly	Hazard not completely, accurately and clearly described
3. Suggested ways of controlling hazards	Complete and doable(practical) and correct	Complete, correct but not very practical	Complete, not very correct, not very practical	Not so complete, not correct, not practical



How Do You Extend Your Learning?

Make a list of hazards that may be present in your own home when operating a personal computer. Give the possible risk of the said hazards.

Hazards at home when operating a computer	Risk
1.	
2.	
3.	
4.	
5.	



What Do You Need To Know?

Read the Information Sheet 1.2 very well then find out how much you can remember and how much you learned by doing Self-check 1.2.

Information Sheet 1.2

Applying 5s on your computer

You work with documents, presentations, graphics, and other files all day—and chances are, you have a lot of them. And that means it takes time to find the documents you need. Even if it is just a couple of minutes here, and a couple of minutes there, it all adds up.

But there is a better way to stop the file clutter—by managing your files more effectively. Digital files are no different than paper files, and if you don't have a good method of organization, things get lost.

Whether you save your files in your computer's hard drive or a shared network location, this course will help you save time and headache of searching for files

The purpose of this instruction is to help you apply 5S concepts to the hard drive of your computer resulting in an increase to your daily productivity, better organization of your computer, and further compliance with the Office 5S initiative. We will cover the following topics as they relate to your hard drive:



5S provides the foundation for all quality improvement programs. Thus, it is often said that the road to productivity starts with 5S and through 5S you can create a highly productive company with highly productive people. 5S is not only a matter of good housekeeping. It is a process to create more productive people and more productive companies through motivation, education, and the practice of 5S. It involves the creation of a strong corporate culture filled with the spirit filled with the spirit of high productivity.

1. **Seiri** Sorting/Putting things in order (Remove/discard what is not needed so that there are fewer hazards and less clutter to interfere with work. Only keep what is needed.)
2. **Seiton** Orderliness/Proper Arrangement (Place things in such a way that they can be easily reached whenever they are needed. "There must be a place for everything, and everything must be in its place.")

3. **Seiso** Clean/cleanliness. (Keep workplace and things clean and polished; no trash or dirt in the workplace)
4. **Seiketsu** Standardize/Purity (Maintain cleanliness after cleaning, consistently-perpetual cleaning. Such cleaning is part of every one's work.)
5. **Shitsuke** Sustaining/discipline/commitment (Maintain standards and keep the facility in safe and efficient order day after day, year after year.)

Example #1: Am I at lost?

It's not unusual for you to see a computer desktop on your classmate's desk that looks something like this:

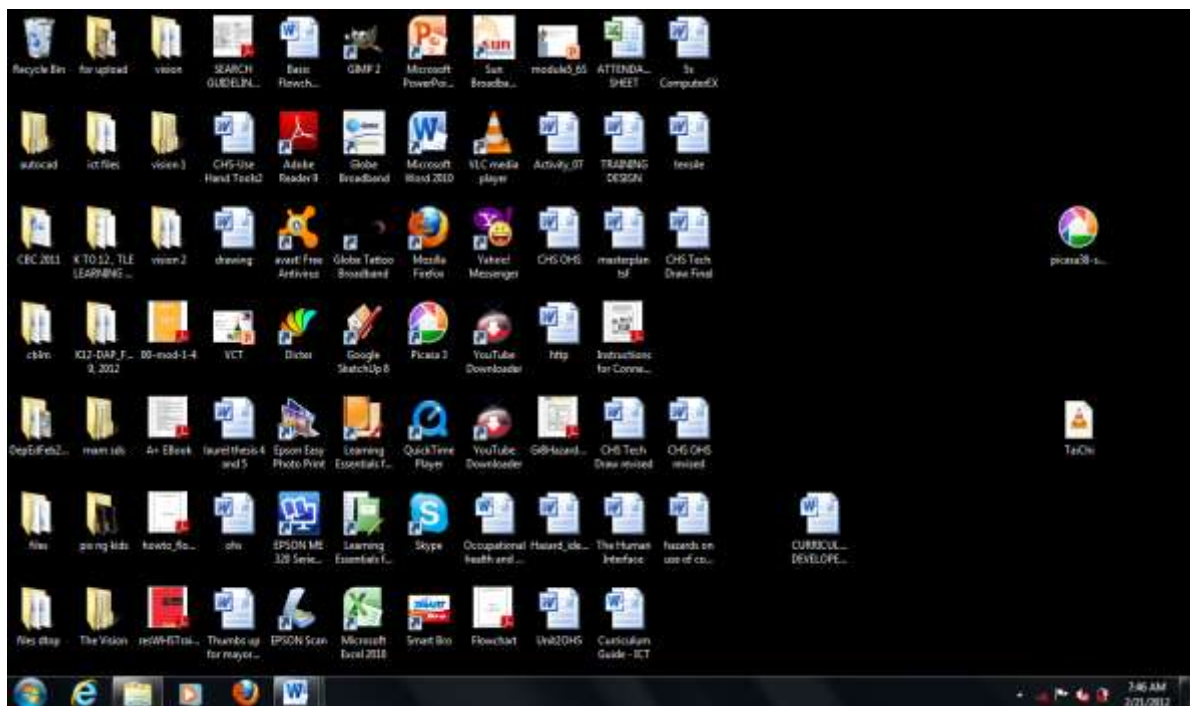

You may have seen even worse. Keeping your desktop so cluttered like this creates many problems such as:

- It is difficult to find what you're looking for.
- Files, folders, and application shortcuts are grouped together without any logical separation.
- You don't know immediately where to place new files (downloaded files, attachments, temporary working documents, etc)
- When the desktop gets too full, you waste time cleaning temporary/downloaded files.
- If you are only backing up My Documents, items on the Desktop may be skipped.
- If you are migrating to a different computer or keeping multiple computers synchronized, the Desktop folder is often missed.

What can you say about the desktop illustrated?

How can you make sure that the above problems will not be encountered?

Consider setting up your files in the tree structure format.

A **tree structure** is an algorithm for placing and locating files in an organized database. The algorithm finds data by repeatedly making choices at decision points called nodes. A node can have as few as two branches (also called children), or as many as several dozen.

In a tree, records are stored in locations called leaves. This name derives from the fact that records always exist at end points; there is nothing beyond them.

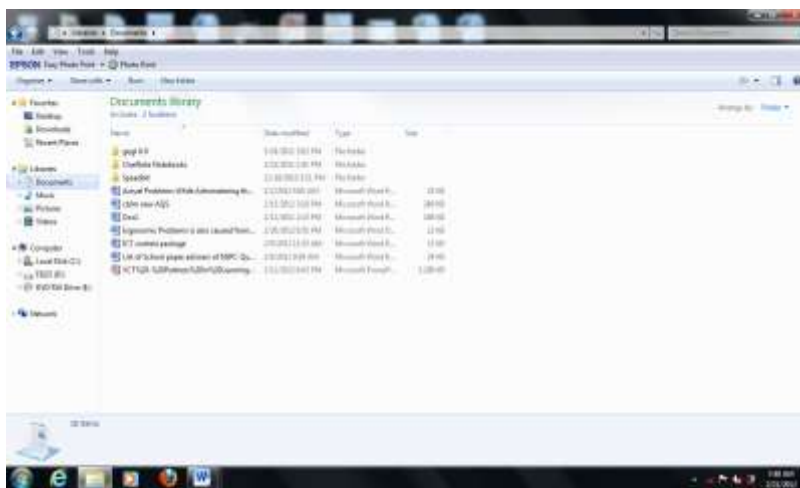

The folder names do not necessarily tell the user what is inside them, making it difficult for yourself and others to find. Also, the folders that are inside don't necessarily belong there or fit with the other files.

Sort – it's the best thing that you can do

Tired of icon clutter on your desktop? Sure, you can organize your desktop shortcuts, programs, folders, and the like by dragging and dropping, but eventually some game or other screen resolution-changing app will undo all your hard work.

Make Yourself a Desktop Cleaner

Your desktop is the first thing you see when you start your computer. This should be the most organized part of your electronic workspace. But what if your desktop looks like this? What will be the impressions on your classmates?

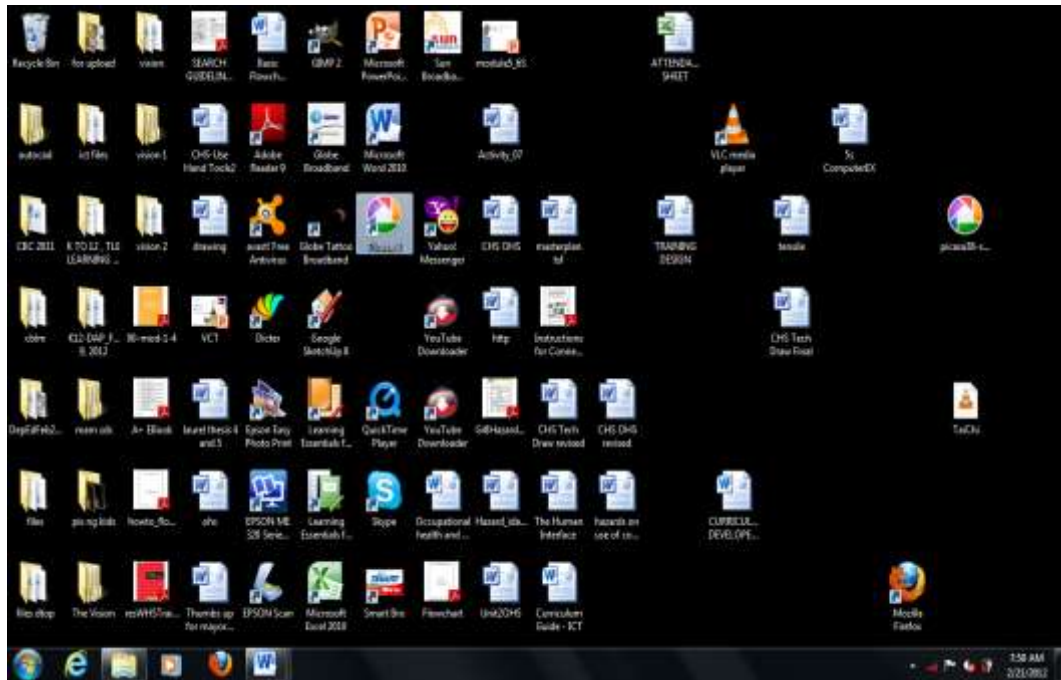

The Desktop offers many features that make using your computer easier. You can easily start programs or applications, copy and move files from one place to another and drag and drop files and program where you want them on the computer or even on to a program's icon to open a file.

Manage Your Own Desktop

Numerous studies have shown that your environment affects your productivity, and that even something as simple as color can influence your memory or creativity. Since most of our work now is done in the digital realm, it stands to reason that your desktop environment can play an important role in your productivity.

Your computer's desktop is a starting point for your entire computing experience, but—like anything else if you let it get ugly and messy your productivity will take a dive. Here's how to design and create an attractive desktop with built-in organization to keep your workspace nice, clean, and productive with minimal effort.

How to manage your desktop:

1. Create 5 folders in My Documents called :

- **Inbox** - Put unprocessed items that don't have a place yet in here. This may be items like software installers you've downloaded, files sent to you from colleagues, and random text clippings.
- **Action Items** - Put items requiring an action that takes more than 2 minutes in here. These may be items such as forms to fill out, large applications to install and setup, and files to upload.
- **On Hold** - Put items you aren't yet ready to do or complete in here. These may be articles you're thinking of reading, sketches for potential projects, and information about classes you're thinking about taking.
- **Current Projects** - Put files related to active projects in here. This folder contains files you're currently working on as well as reference files for a project. Each project gets its own unique folder.
- **Archive** - Put completed projects, general reference items, and anything else you might want to look at again in here



Tip: By placing the underscore in front of the name of the file folder, it will force the folder to display at the top of the list in My Documents.



2. Now move all relevant files from your desktop into these folders. If you have a large number of files, you can move everything into the "Inbox" folder and organize it later.
3. All that should be left on the desktop is program icons.







How Much Have You Learned?

Self-Check 1.2

Directions: Match the 5S principle that is needed or depicted in the following pictures.

Column A	Column B
1. Seiton	a. 
2. Seiri	b. 

3. Seiketsu		<p>c.</p> 
4. Seiso		<p>d.</p> 
5. Shitsuke		<p>e.</p> 
		<p>f.</p> 

Refer to the Answer Key. What is your score?



How Do You Apply What You Have Learned?

Show that you learned something by doing this activity.

Operation Sheet 1.1

Directions: Organize your desktop. Name the folders below and organize your own desktop by sorting the given files accordingly.



Files

1. YouTube downloader
2. House.jpeg
3. Firezilla
4. Deped memorandum .pdf
5. Letter to the principal .doc
6. Group project proposal
7. Proposed program of activities
8. School.jpeg
9. Video of the school activities
10. My resume.doc
11. Harry Potter movie
12. School Hymn
13. Teach me how to doggy.mp3
14. List of activies.doc
15. Importance of Facebook usage.ppt

File folder name

- 1.
- 2.
- 3.
- 4.
- 5.
- 6.
- 7.
- 8.
- 9.
- 10.
- 11.
- 12.
- 13.
- 14.
- 15.



How Well Did You Perform?

**Find out by accomplishing the Scoring Rubric honestly and sincerely.
Remember it is your learning at stake!**

Scoring Rubrics

Criteria	Points	My Score
1. Accuracy	50	
2. Speed	25	
3. w/o Assistance	25	
Total	100	

LEARNING OUTCOME 2

Evaluate hazards and risk

PERFORMANCE STANDARDS

1. Effects of hazards are determined.
2. OSH issues and concerns are identified in accordance with workplace requirements and
3. Relevant workplace OSH legislation.



Materials

1. Workplace
2. Personal protective equipment (PPE)
3. Learning guides
4. Hand-outs
 - Organizational safety and health protocol
 - 5S
 - Hazards/risk identification and control



What Do You Already Know?

Let us determine how much you already know about the evaluation of hazards and risk. Take this test.

Pretest LO 2

Direction: Read each statement below carefully. Place **T** on the line, if you think a statement is **TRUE**. Place **F**, if you think the statement is **FALSE**.

- _____ 1. Your knees should be bent at a comfortable angle and greater than 90 degrees flexion when sitting in front of a computer.
- _____ 2. A well designed mouse should not cause undue pressure on the wrist and forehead muscles.
- _____ 3. Set the eye to screen distance that permits you to most easily focus on the screen.
- _____ 4. Changing posture at frequent intervals maximizes fatigue when using a computer.
- _____ 5. Place the keyboard in a position that allows the forearms to be close to the horizontal and the wrists to be straight.
- _____ 6. It is recommended that operators avoid spending more than five hours a day on keyboard duties and no longer than 50 minutes per hour without a postural/stretching break.
- _____ 7. To detect whether there are reflections from the desk surface, the worker should hold the book below the surface and assess the change in reflected glare from the screen.
- _____ 8. 10,000 - 12,000 keystrokes per hour is considered an acceptable standard in typing.
- _____ 9. Good posture is essential for all users of computers.
- _____ 10. The solution is to increase the refresh rate of the monitor to at least 75hz.



What Do You Need To Know?

Read the Information Sheet 2.1 very well then find out how much you can remember and how much you learned by doing Self-check 2.1.

Information Sheet 2.1

Computer Workstation Ergonomics

There are various health problems associated with the regular use of computers, such as stress, eyestrain, and injuries to the wrists, neck, and back.

Employers must take steps to protect employees whose work involves the regular use of computers.

Computer ergonomics is the discipline of matching the task to the worker using the most appropriate equipment to optimize human well-being and overall performance. This can be simplified to "Modify the workplace, not the individual".

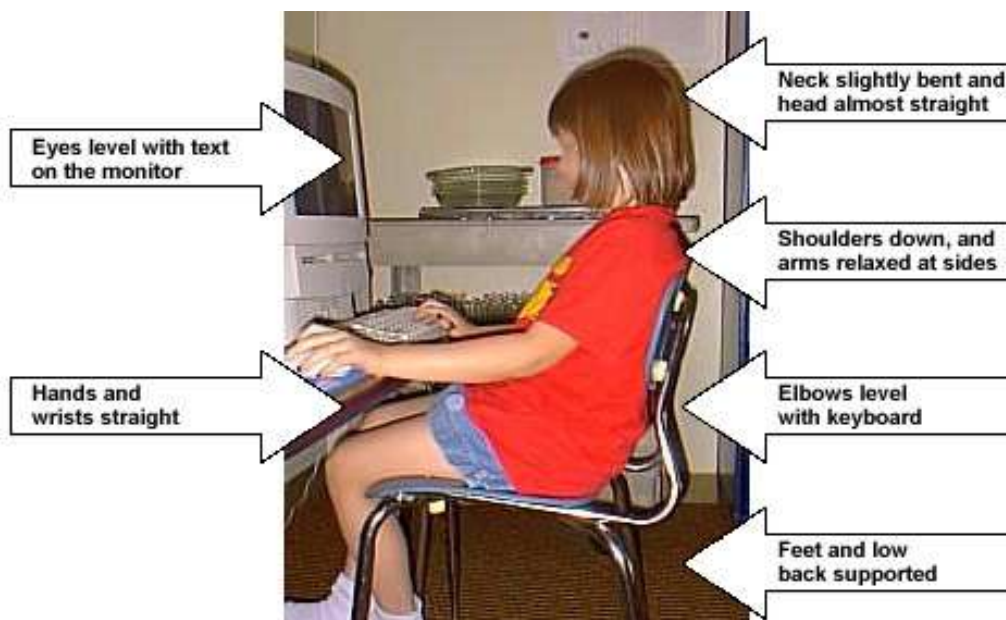

Consideration should be given to:

- The accessories required to operate properly
- The layout of equipment on the desk
- The location of furniture in the room

Computer workplace



Work surface height

Adjust the height of the work surface and/or the height of the chair so that the work surface allows your elbows to be bent at 90 degrees, forearms parallel with the floor, wrist straight, shoulders relaxed.

Chair

Adjust the seat tilt so that you are comfortable when you are working on the keyboard. Usually, this will be close to horizontal but some people prefer the seat tilted slightly forwards. Your knees should be bent at a comfortable angle and greater than 90 degrees flexion. If this places an uncomfortable strain on the leg muscles or if the feet do not reach the floor then a footrest should be used. The footrest height must allow your knees to be bent at 90 degrees. Therefore the height of the footrest may need to be adjustable. Adjust the backrest so that it supports the lower back when you are sitting upright.

Keyboard placement

Place the keyboard in a position that allows the forearms to be close to the horizontal and the wrists to be straight. That is, with the hand in line with the forearm. If this causes the elbows to be held far out from the side of the body then re-check the work surface height. Some people prefer to have their wrists supported on a wrist desk or the desk. Be careful not to have the wrist extended or bent in an up position.



Screen placement

Set the eye to screen at the distance that permits you to most easily focus on the screen. Usually, this will be within an arm's length. Set the height of the monitor so that the top of the screen is below eye level and the bottom of the screen can be read without a marked inclination of the head. Usually, this means that the center of the screen will need to be near shoulder height. Eyes must be level with the tool bar. People who wear bifocal or multi-focal lenses will need to get a balance between where they see out of their lenses and avoid too much neck flexion.

Desk-top layout

Place all controls and task materials within a comfortable reach of both hands so that there is no unnecessary twisting of any part of the body. Most people prefer the document holder to be between the keyboard and the monitor. There are many different types of document holders available.

Document holder

Place this close to the monitor screen in the position that causes the least twisting or inclination of the head.

Posture and environment

Change posture at frequent intervals to minimize fatigue. Avoid awkward postures at the extremes of the joint range, especially the wrists. Take frequent short rest breaks rather than infrequent longer ones. Avoid sharp increases in work rate. Changes should be gradual enough to ensure that the workload does not result in excessive fatigue. After prolonged absences from work the overall duration of periods of keyboard work should be increased gradually if conditions permit



Bad posture

Lighting

Place the monitor to the side of the light source/s, not directly underneath. Try to site desks between rows of lights. If the lighting is fluorescent strip lighting, the sides of the desks should be parallel with the lights. Try not to put the screen near a window. If it is unavoidable, ensure that neither the screen nor the operator faces the window. The solution is to increase the refresh rate of the monitor to at least 75hz.

If the monitor is well away from windows, there are no other sources of bright light and prolonged desk-work is the norm, use a low level of service light of 300 lux. If there are strongly contrasting light levels, then a moderate level of lighting of 400 - 500 lux may be desirable.

Glare and reflection

It is important to detect the presence of glare and reflection. To determine whether there is glare from overhead lights whilst seated worker should hold an object such as a book above the eyes at eyebrow level and establish whether the screen image becomes clearer in the absence of overhead glare. To detect whether there are reflections from the desk surface, the worker should hold the book above the surface and assess the change in reflected glare from the screen.

Using a mouse

A well designed mouse should not cause undue pressure on the wrist and forearm muscles. A large bulky mouse may keep the wrist continuously bent at an uncomfortable angle. Pressure can be reduced by releasing the mouse at frequent intervals, by selecting a slim-line, low-profile mouse. Keep the mouse as close as possible to the keyboard, elbow bent and close to the body.

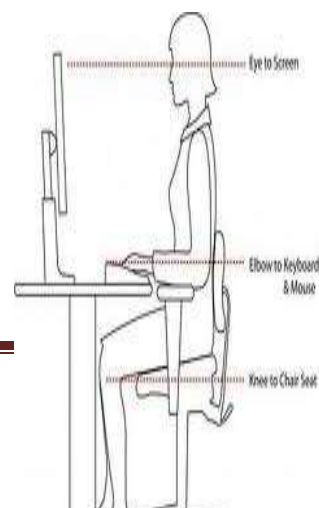

good posture

Good posture is essential for all users of computers. It comprises of a natural and relaxed position, providing opportunity for movement, and from which the operator can assume a number of alternative positions. **It is not a single, rigidly defined position.**

Typing technique

Typing is a physical activity, and using a keyboard requires skill, hence the need to learn correct typing technique. Unskilled ('hunt and peck') typists are particularly at risk of Occupational Overuse Injury because they:

- often use only one or two fingers which may overload the finger tendons;
- are constantly looking from keyboard to screen to keyboard, which may strain neck muscles;
- often adopt a tense posture (wrists bent back and fingers 'poised to strike').

Speed of keying

The efficiency and speed of modern computers makes it possible for a skilled operator to type extremely quickly. This capability, reinforced by workload pressures means the potential exists for operators to key at speeds which may cause or contribute to Occupational Overuse Syndrome.

The role of the repetitive movement in injury is not fully understood, but is believed to interfere with the lubrication capacity of tendons, and the ability of muscles to receive sufficient oxygen supplies. 10,000 - 12,000 keystrokes per hour is considered an acceptable standard.

Length of time on the keyboard

The maintenance of a fixed posture for long periods is tiring and increases the likelihood of muscular aches and pains. In addition, long periods of repetitive movement and sustained visual attention can also give rise to fatigue-related complaints.

It is recommended that operators avoid spending more than five hours a day on keyboard duties and no longer than 50 minutes per hour without a postural/stretching break.

POINTS TO REMEMBER

Computers –Ergonomic Guidelines



- ✓ **Viewing distance:** The monitor should be 2 –2½ feet from the child's eyes.
- ✓ **Time at computer:** Encourage children to use their physical energy.
- ✓ **Seat and height posture:** The child should sit high enough to have his arms bent at 90°
- ✓ **Footrest:** Use it prevent dangling feet.
- ✓ **Mouse:** Find one that fits small hands.
- ✓ **Keyboard:** Child-sized keyboards with light pressure keying are recommended.



How Much Have You Learned?

Self-Check 2.1

Direction: Read each statement below carefully. Place **T** on the line, if you think a statement is **TRUE**. Place **F**, if you think the statement is **FALSE**.

- _____ 1. Your knees should be bent at a comfortable angle and greater than 90 degrees flexion when sitting in front of a computer.
- _____ 2. A well-designed mouse should not cause undue pressure on the waist and forehead muscles.
- _____ 3. Set the eye to screen at a distance that permits you to most easily focus on the screen.
- _____ 4. Changing posture at frequent intervals maximizes fatigue when using a computer.
- _____ 5. Place the keyboard in a position that allows the forearms to be close to the horizontal and the wrists to be straight.
- _____ 6. It is recommended that operators avoid spending more than five hours a day on keyboard duties and no longer than 50 minutes per hour without a postural/stretching break.
- _____ 7. To detect whether there are reflections from the desk surface, the worker should hold the book below the surface and assess the change in reflected glare from the screen.
- _____ 8. 10,000 - 12,000 keystrokes per hour is considered an acceptable standard in typing.
- _____ 9. Good posture is essential for all users of computers.
- _____ 10. The solution is to increase the refresh rate of the monitor to at least 75hz.

Refer to the Answer Key. What is your score?



How Do You Apply What You Have Learned?

Show that you learned something by doing this activity.

Operation Sheet 2.1

Directions: Review the Hazard Evaluation sample exercise with the class. Explain that there is personal judgment involved in evaluating hazards. For example, a large bulky mouse may keep the wrist continuously bent at an uncomfortable angle.

Answer handout 1 for an individual learning activity. Ask students to choose one job (either computer technician or computer programmer) or activity at work or at home. List potential A, B and C type **hazards on computer ergonomics** for the job or activity on the worksheet and give reasons for the type of hazard.

Name: _____	HAZARDS EVALUATION (Computer Ergonomics)		_____ : Date
Setting : Computer Laboratory	Hazard A: Can cause serious injury. Must be corrected immediately.		
Activity /Job : Computer Technician	Hazard B : Must be corrected soon to avoid injury.		
Location : Philippines	Hazard C : Not an immediate concern. Plan to correct in future.		
Hazard A	Hazard B	Hazard C	
(Example) 1. <i>Overloaded Electrical sockets</i>	(Example) 1. <i>Computer screen near a window.</i>	(Example) 1. <i>Large bulky mouse may keep the wrist continuously bent at an uncomfortable angle.</i>	
Reasons why :	Reasons why :	Reasons why :	



How Well Did You Perform?

**Find out by accomplishing the Scoring Rubric honestly and sincerely.
Remember it is your learning at stake!**

Activity	4	3	2	1
Identifying hazards and Risk	Students identify more than 4 hazards and risks.	Students identify at least 4 reasonable, hazards and risks.	Students identify at least 3 reasonable, hazards and risks.	Students identify less than 3 hazards and risks.
Controlling hazards and Risk	Students identify more than 4 reasonable, insightful possible solutions/strategies to control hazards and risk	Students identify at least 4 reasonable, insightful possible solutions/strategies to control hazards and risk	Students identify at least 3 reasonable, insightful possible solutions/strategies to control hazards and risk	Students identify fewer than 3 reasonable, insightful possible solutions/strategies to control hazards and risk

LEARNING OUTCOME 3

Control hazards and risk

PERFORMANCE STANDARDS

1. OHS procedures for controlling hazards and risk are strictly followed.
2. Procedures in dealing with workplace accidents, fire and emergencies are followed in accordance with the organization's OSH policies.



Materials

1. Workplace
2. Personal protective equipment (PPE)
3. Learning guides
4. Hand-outs
 - Organizational safety and health protocol
 - 5S
 - Hazards/risk identification and control



What Do You Already Know?

Let us determine how much you already know about the control of hazards and risk . Take this test.

Pretest LO 3

A. Directions: List down at least five ways to control hazards in the computer work place

1. _____
2. _____
3. _____
4. _____
5. _____

B. Directions: Read each statement below carefully. Place **T** on the line, if you think the statement is **TRUE**. Place **F** if you think the statement is **FALSE**.

_____ 1. The right lighting can reduce eyestrain, neck strain, and headaches.

_____ 2. When you type, hold your fingers, wrists, and lower arms in a straight line from your keyboard.

_____ 3. The computer desk should be deep enough to support your arms when you work at the computer.

_____ 4. When using a computer, keep your feet flat on the floor and your knees slightly lower than your thighs.

_____ 5. Substitution of a specific hazard or hazardous work process, or preventing it from entering the workplace, is the most effective method of control.



What Do You Need To Know?

Read the Information Sheet 3.1 very well then find out how much you can remember and how much you learned by doing Self-check 3.1.

Information Sheet 3.1

Controlling hazards and Risk

All workplace hazards (chemical, physical, etc.) can be controlled by a variety of methods. The goal of controlling hazards is to **prevent workers from being exposed to occupational hazards**. Some methods of hazard control are more efficient than others, but a combination of methods usually provides a safer workplace than relying on only one method. Some methods of control are cheaper than others but may not provide the most effective way to reduce exposures.

The most effective method of controlling hazards is to control at the source by eliminating the hazard or by substituting a hazardous agent or work process with a less dangerous one.

Before thinking about what control measures are needed, first you need to know whether there are health and safety problems in your workplace, and if so, what they are.

How can you identify health and safety problems?

Here are some of the ways you can identify health and safety problems:

- Observe your workplace;
- Investigate complaints from workers;
- Examine accident and near-miss records;
- Examine sickness figures;
- Use simple surveys to ask your co-workers about their health and safety concerns;
- Use checklists to help you inspect your workplace;
- Learn the results of inspections that are done by the employer, the union, or anyone else;
- Read reports or other information about your workplace.



Once you recognize a hazard, then you can determine which measure will correct the problem most effectively. Generally, there are five major categories of control measures: elimination, substitution, engineering controls, administrative controls, and personal protective equipment. Eliminating a hazard means removing it completely; substitution is

replacing one hazardous agent or work process with a less dangerous one. An engineering control may mean changing a piece of machinery (for example, using proper machine guards) or a work process to reduce exposure to a hazard; working a limited number of hours in a hazardous area is an example of an administrative control (for example, job rotation); and personal protective equipment (PPE) includes ear and eye protection, respirators, and protective clothing.

Remember: *it is always better to control the hazard as close to the source as possible. Using personal protection is the least acceptable and least effective of all control measures.*

Methods of Control

Elimination

Elimination of a specific hazard or hazardous work process, or preventing it from entering the workplace, is the most effective method of control.

Eliminate hazards at the “development stage”

It is important to consider the worker’s health and safety when work processes are still in the planning stage. For example, when purchasing machines, safety should be the first concern, not cost. Machines should conform to national safety standards. They should be **designed** with the correct guard on them to eliminate the danger of a worker getting caught in the machine while using it. Machines that are not produced with the proper guards on them may cost less to purchase, but cost more in terms of accidents, loss of production, compensation, etc. Unfortunately, many used machines that do not meet safety standards are exported to developing countries, causing workers to pay the price with accidents, hearing loss from noise, etc.

Where are controls used?

Controls are usually placed:

1. At the source (where the hazard "comes from")
2. Along the path (where the hazard "travels")
3. At the worker



What is meant by elimination?

Elimination is the process of removing the hazard from the workplace. It is the most effective way to control a risk because the hazard is no longer present. It is the preferred way to control a hazard and should be used whenever possible.

What is substitution?

Substitution occurs when a new chemical or substance is used instead of another chemical. It is sometimes grouped with elimination because, in effect, you are removing the first substance or hazard from the workplace. The goal, obviously, is to choose a new chemical that is less hazardous than the original.



Education and Training

Employee education and training on how to conduct their work safely helps to minimize the risk of exposure and is a critical element of any complete workplace health and safety program. Training must cover not only how to do the job safely but it must also ensure that workers understand the hazards of their job. It must also provide them with information on how to protect themselves and co-workers.

Good Housekeeping

Good housekeeping is essential to prevent the accumulation of hazardous or toxic materials (e.g., build-up of dust or contaminant on ledges, or beams), or hazardous conditions (e.g., poor stockpiling).

Emergency Preparedness

Being prepared for emergencies means making sure that the necessary equipment and supplies are readily available and that employees know what to do when something unplanned happens such as a release, spill, fire, or injury. These procedures should be written and employees should have the opportunity to practice their emergency response skills regularly.

What should I know about personal protective equipment (PPE) as a hazard control method?

Personal protective equipment (PPE) includes items such as respirators, protective clothing such as gloves, face shields, eye protection, and footwear that serve to provide a barrier between the wearer and the chemical or material.

It is the final item on the list for a very good reason. Personal protective equipment should never be the only method used to reduce exposure except under very specific circumstances because PPE may "fail" (stop protecting the worker) with little or no warning. For example: "breakthrough" can occur with gloves, clothing, and respirator cartridges.

Why is it important to monitor and review your hazard control program and methods?

It is important to monitor both the hazard and the control method to make sure that the control is working effectively and that exposure to the hazard is reduced or eliminated.

Some tools include physical inspection, testing, exposure assessment, observations, injury and illness tracking, employee feedback/input, occupational health assessment, and other methods.

Be sure to answer the following questions:

- Have the controls solved the problem?
- Is the risk posed by the original hazard contained?
- Have any new hazards been created?
- Are new hazards appropriately controlled?
- Are monitoring processes adequate?
- Have workers been adequately informed about the situation?
- Have orientation and training programs been modified to deal with the new situation?
- Are any other measures required?
- Has the effectiveness of hazard controls been documented in your committee minutes?
- What else can be done?



Effective Hazard Control Program

A review will identify areas that may need more improvement or refinement. It is important to know if all workplace hazards are identified, assessed, and appropriately controlled.

The workplace can be a dangerous place if various safety procedures are not properly considered. Some precautions which can be taken to reduce the risk of accidents are:

- Ensure there are no trailing wires across or around the room which people could trip on.
- Power cables should be safely secured.
- Electrical sockets should not be overloaded.
- Electrical equipment should be safety tested at least once a year.
- There should be adequate space around desks for people to move.
- Bags and obstacles should be stored out of the way so that people can't trip over them.
- Food and drink should not be placed near a machine.
- Heating and ventilation should be suitable for the working environment.
- Work desks should be strong enough to support computers and equipment.
- Staff should follow the safety regulations.
- This is the science concerned with designing safe and comfortable machines for use by people.
- This includes furniture design and the design of peripherals that you need to use, such as mouse and keyboard.





Have a look at these top tips to ensure that you work safely and comfortably:

1. The right lighting can reduce eyestrain, neck strain, and headaches. Sunlight is the best light, but make sure it doesn't create glare on your computer screen.
2. The proper desk will let you find the perfect working position. It should be deep enough to support your arms when you work at the computer.
3. Place your computer screen at eye-level or just below. For optimal comfort, set it about 45 cm (18 in.) from your face.
4. Sit up straight in your chair. Keep your feet flat on the floor and your knees slightly lower than your thighs.
5. Choose an office task chair that lets you tilt forward to reach objects in front of you and backward to stretch your arms when you're tired.
6. When you type, hold your fingers, wrists, and lower arms in a straight line from your keyboard.
7. Keep equipment that you use a lot, like your telephone and computer keyboard, within a distance of about 75 cm (30 in.) when you're sitting at your desk. Keep other storage and equipment farther away. This encourages you to change working positions during the day.



Points to remember

1. Occupational hazards can be controlled by a variety of methods.
2. The goal of controlling hazards is to prevent workers from being exposed to occupational hazards.
3. The most effective control measure is to control hazards at the source by eliminating the hazard or by substituting a hazardous chemical, machine, work process, etc., with a less dangerous one.
4. It is important to recognize hazards and health and safety problems in the workplace.
5. There are five general categories of control measures: elimination, substitution, engineering controls, administrative controls and personal protective equipment. A combination of methods usually provides a safer and healthier workplace than relying on only one method.
6. Personal protective equipment should be the last choice in control measures.

Remember the 3 steps to controlling a hazard.



See it. - Identify the hazards. What is unsafe?



Think It. - Evaluate the hazard. What could happen?



Do It. - Provide solutions to control or eliminate the hazard.



How Much Have You Learned?

Self-Check 3.1

Directions: Search for the ten (10) different methods used to control hazards and risks. Encircle the word/ words vertically, horizontally, backward, upward or downward.

E	L	I	M	I	N	T	I	O	N	T	E	A	A	G
A	A	D	E	D	F	G	H	Y	I	G	D	M	S	O
T	R	T	Y	U	I	O	P	A	Y	B	C	E	D	O
S	E	A	S	F	G	H	K	T	Y	V	G	T	F	D
S	D	A	S	E	D	O	E	R	A	C	N	H	G	H
T	R	A	I	N	I	N	G	F	F	O	O	O	H	O
T	A	I	X	E	T	G	G	S	I	Y	I	D	J	U
T	A	A	F	F	F	F	B	T	E	H	T	S	K	S
A	O	E	E	D	U	I	I	B	H	N	A	F	L	E
N	I	O	P	S	A	T	D	G	F	H	C	G	X	K
A	N	A	T	I	S	A	S	E	R	T	U	S	C	E
U	R	E	Y	B	O	C	O	L	L	E	D	A	V	E
A	E	O	U	R	O	N	A	L	D	A	E	C	B	P
N	A	S	I	A	G	H	K	L	I	O	L	O	N	I
C	N	E	N	A	W	H	A	Z	A	R	D	S	M	N
I	A	W	E	I	N	M	L	W	E	Y	U	I	F	G
T	R	I	S	K	W	Q	A	N	A	W	I	N	N	E
Y	W	E	O	A	C	R	A	M	I	L	O	A	H	A

Refer to the Answer Key. What is your score?



How Do You Apply What You Have Learned?

Show that you learned something by doing this activity.

Operation Sheet 1.1

Directions : Ask students to work in small groups (2-4 persons) and think about specific, possible computer laboratory or classroom hazards that could fall into the categories listed in *handout below*. Allow 10 minutes.

Debrief the activity in a large group by asking the students what they thought might be hazards. Write their responses on the left side of a flipchart. Ask the students to speculate about the kind of injuries that could result from each hazard and write these on the right side of the flipchart.

Make suggestions that will control the risk and hazards identified into an innovative and creative way like poster, brochure, and leaflets or through a Facebook Fun Page.

Handout 3.1 COMPUTER LABORATORY/CLASSROOM HAZARDS CONDITION

Indicators	Observation
<p style="text-align: center;">Computer Lab / Classroom</p> <ol style="list-style-type: none"> 1. Is the housekeeping satisfactory? 2. Is the lighting adequate? 3. Is the floor in good condition? 4. Are the aisle widths and other paths of travel adequate? 5. Are the entrances and exits adequate? 6. Are emergency procedures (with guidelines for disabled persons) clearly posted? 7. Is the classroom furniture in good repair and positioned safely? <p style="text-align: center;">Power Cords and Cables</p> <ol style="list-style-type: none"> 1. Are the proper cords and plugs used? 2. Are all cords in good condition (no fraying or exposed wires)? 3. Are all plugs in good condition (no cracks or broken pieces) and firmly attached to cords? 4. Are cords secured to avoid a tripping hazard? <p style="text-align: center;">Chairs</p> <ol style="list-style-type: none"> 1. Are the chairs adjustable? 2. Does the backrest adequately support the lumbar area? 3. Do chairs have rounded seat edges to help maintain blood circulation in the legs? 4. Does the seat allow for the comfortable and supportive positioning of the legs, torso and arms? 	

Mice and Keyboards

1. Are wrist or palm rests available?
2. Is a variety of mice available to fit the different sized hands of students?
3. Can the height of the mouse be adjusted so it is located beside the body just above the keyboard tray?
4. Is the height of keyboards adjustable?
5. Is keystroke pressure adjustable?
6. Is the angle of the keyboard adjustable (to maintain the hands in a neutral hand position)?
7. Are portable keyboards (which tend to be smaller than regular keyboards) or reduced size keyboards available for students with smaller hands?

Monitors (video display terminals)

1. Can workstations (chair, monitor, etc.) be arranged so:
 - the top of the screen is at eye level (or a level that doesn't stress the neck or eyes)?
 - their eyes are a comfortable distance from the screen (usually about one arm length)?
 - the keyboard is just below elbow height
2. Are monitors placed perpendicular to windows to reduce glare?
3. Are anti-glare screens available?
4. Does the work surface have an anti-glare surface to reduce light reflection?



How Well Did You Perform?

Find out by accomplishing the Scoring Rubric honestly and sincerely. Remember it is your learning at stake!

Activity	4	3	2	1
Identifying hazards and Risk	Students identify more than 4 reasonable, insightful barriers/problems that need to control hazards and risks.	Students identify at least 4 reasonable, insightful barriers/problems that need to control hazards and risks.	Students identify at least 3 reasonable, insightful barriers/problems that need to control hazards and risks.	Students identify fewer than 3 reasonable, insightful barriers/problems that need to control hazards and risks.
Controlling hazards and Risk	Students identify more than 4 reasonable, insightful possible solutions/strategies to control hazards and risks.	Students identify at least 4 reasonable, insightful possible solutions/strategies to control hazards and risks.	Students identify at least 3 reasonable, insightful possible solutions/strategies to control hazards and risks.	Students identify fewer than 3 reasonable, insightful possible solutions/strategies to control hazards and risks.



How Do You Extend Your Learning?

Directions: Complete the Table below by analyzing the task given.

Your Task:

Think about what your first (next) job might be in the future.
In your mind make a picture of how your workplace looks like.
Think about how you could answer the following questions.

MY TRIAL RUN FOR MY FUTURE: See it! Think it! Do it!

See it! Think It! Do It!	
Questions	Situations
1. Describe one unsafe situation you might find at work.	
2. Why is this a hazardous situation?	
3. What injury or health problem could result?	
4. How can you prevent an accident from happening?	



Congratulations! You did a great job! Rest and relax.

REFERENCES

LO1

- Bahr, N. J., "System Safety Engineering and Risk Assessment: A Practical Approach", Taylor and Francis, 1997
- <http://www.austlii.edu.au>

LO 2

- http://www.michigan.gov/documents/4-pub207_60737_7.pdf
- <http://www.empf.org/empfasis/aug04/prop.htm>

LO 3

- <http://www.lakeland.cc.il.us/>
- <http://www.waset.org/journals/waset/v48/v48-76.pdf>
- <http://www.leankaizen.co.uk/5s-your-computer.htm>

ANSWER KEYS

LESSON 1

LO1 AND LO2 PLAN AND PREPARE FOR TASKS TO BE UNDERTAKEN AND PREPARE HAND TOOLS

PRETEST

A.

1. True
2. True
3. False
4. True
5. False
6. True

B.

1. A - Antistatic mat
2. C – Philips head screwdriver
3. B – Hex driver
4. D – Wire cutter
5. A – Part retriever
6. B – Lint-free cloth
7. C – Cable ties
8. D – Flat head screwdriver
9. B – Torx screwdriver
10. C – Compressed air

SELF-CHECK

A.

1. True
2. True
3. False
4. True
5. False
6. True

B.

1. Antistatic Wrist Strap
2. Flat Head Screwdriver
3. Flashlight
4. Lint-free Cloth
5. Multimeter
6. Antistatic Mat
7. Philips Head Screwdriver
8. Part Retriever
9. Compressed Air

10. Loopback Adapter
11. Torx Screwdriver
12. Tweezers
13. Hex Driver
14. Needle-nose Plier

LO3. USE APPROPRIATE HAND TOOLS AND TEST EQUIPMENT

PRETEST

1. equalize
2. clockwise
3. counterclockwise
4. philips
5. insulator
6. four.
7. lead
8. distilled
9. isopropyl
10. hex driver

SELF-CHECK

A.

1. Antistatic Wrist Strap
2. Philips Head Screwdriver
3. Hex driver
4. Tweezers / needle-nose pliers
5. Flat Head Screwdriver

B.

COMPONENTS TO CLEAN	CLEAN WITH:
Computer case and outside monitor	Mild cleaning solution and lint free cloth (sample)
Keyboard	Compressed air and brush
Mouse	Mild cleaning solution and lint-free cloth
LCD screen	LCD cleaning solution or distilled water and lint-free cloth
CRT screen	Distilled water and lint-free cloth
Heat sink	Compressed air
RAM	Isopropyl alcohol and lint-free cloth

LO4. MAINTAIN HAND TOOLS

PRETEST

1. True
2. True
3. True
4. True
5. True
6. True
7. True
8. True

SELF-CHECK

Good practices of proper storage of tools: (at least 2)

1. Parts should be properly stored and labeled.
2. Tools should be properly placed on the board, and labeled. Consider drawing the shapes of the tools on the board so that they always get put back in the same position.
3. Use bins for storing small parts.
4. Consider making an individual (or individuals) responsible for the good maintenance of tools and parts

Benefits of proper storage of tools: (at least 2)

1. Tools and parts are kept in good condition and are easy to find
2. Costs are reduced
3. Productivity is increased because time is not lost looking for tools, parts and equipment
4. Workshop staff develop a sense of responsibility and pride in their work

LESSON 2

LO1. SELECT COMPONENTS TO BE MEASURED

PRETEST

1. C
2. I
3. D
4. F
5. G
6. E
7. J
8. B
9. A
10. H

SELF-CHECK

1. I
2. D
3. F
4. G
5. E
6. J
7. B
8. C
9. A
10. H

LO2. CARRY OUT MEASUREMENTS AND CALCULATION

PRETEST

- 1) Convert 14 to binary number.

	Quotient	Remainder
14/2	7	0
7/2	3	1
3/2	1	1
1/2	0	1

Answer: 14 = 1110

Checking: 1 1 1 0 multiplier
8 4 2 1 equivalents
8 4 2 0 results

$$8+4+2 = 14$$

- 2) If a 10 KB file is stored in a 1 MB folder, then approximately how many files can be stored in that folder?

$$1 \text{ KB} = 1,024 \text{ Bytes}$$

$$10 * 1,024 = 10,240 \text{ bytes in a 10 KB file}$$

$$1 \text{ MB} = 1,048,576 \text{ Bytes}$$

$$1,048,576 / 10,240 = 102.4$$

Answer: Approximately 102 files

SELF-CHECK

Convert the decimal numbers shown below to binary. Perform checking to verify answers.

1) 19

	Quotient	Remainder
19/2	9	1
9/2	4	1
4/2	2	0
2/2	1	0
1		

Answer: 19 = 10011

Checking:	1	0	0	1	1	multiplier
	16	8	4	2	1	equivalents
	16 + 2 + 1 = 19					

2) 28

	Quotient	Remainder
28/2	14	0
14/2	7	0
7/2	3	1
3/2	1	1
1		

Answer: 28 = 11100

Checking:	1	1	1	0	0	multiplier
	16	8	4	2	1	equivalents
	16 + 8 + 4 = 28					

3) 37

	Quotient	Remainder
37/2	18	1
18/2	9	0
9/2	4	1
4/2	2	0
2/2	1	0
1		

Answer: 37 = 100101

Checking:	1	0	0	1	0	1	multiplier
	32	16	8	4	2	1	equivalents
	32 + 4 + 1 = 37						

LESSON 3

LO1. IDENTIFY DIFFERENT KINDS OF TECHNICAL DRAWINGS.

PRETEST

1. e
2. a
3. d
4. c
5. b

SELF-CHECK

1. b
2. a
3. d
4. c
5. e

LO2. INTERPRET TECHNICAL DRAWING.

PRETEST

SELF-CHECK

1. 2
2. 1
3. 5
4. 6
5. 3
6. 4

LESSON 4

LO1. IDENTIFY HAZARDS AND RISKS.

PRETEST

A.

1. b
2. a
3. d
4. c
5. e

B.

1. seiri
Example : *answer may vary*
2. seiton

Example : *answer may vary*

3. seiso

Example : *answer may vary*

4. seiketsu

Example : *answer may vary*

5. Shitsuke

Example : *answer may vary*

SELF-CHECK 1.1

A.

1. T
2. F
3. T
4. F
5. T

B.

1. physical hazard
2. mechanical hazard
3. chemical hazard
4. physical hazard
5. electrical hazard

SELF-CHECK 1.2

1. b.
2. a.
3. d.
4. c.
5. e.

LO2. EVALUATE HAZARDS AND RISKS.

PRETEST

1. T
2. F
3. T
4. F
5. T
6. T
7. F
8. T
9. T
10. T

SELF-CHECK

1. T
2. F
3. T
4. F
5. T
6. T
7. F
8. T
9. T

LO3. CONTROL HAZARDS AND RISKS.

PRETEST

A.

1. Answer may vary
2. Answer may vary
3. Answer may vary
4. Answer may vary
5. Answer may vary

B.

1. T
2. T
3. T
4. T
5. F

SELF-CHECK

E	L	I	M	I	N	T	I	O	N					G
												M		O
												E		O
												T		D
											N	H		H
T	R	A	I	N	I	N	G			O	O	O		O
									I		I	D		U
								T			T	S		S
							I				A			E
						T					C			K
					S						U			E
			B								D			E
		U									E			P
	S													I
						H	A	Z	A	R	D	S		N
														G
	R	I	S	K										

Acknowledgement

This Learning Module was developed for the Exploratory Courses in Technology and Livelihood Education, Grades 7 and 8 of the K to 12 Curriculum with the assistance of the following persons:

This Learning Module on **Computer Hardware Servicing** was developed by the following personnel:

MODULE WRITERS

RONALDO V. RAMILO

Division ICT Coordinator
Tanauan City Division
Tanauan City - Region IV-A Calabarzon

DEOVER M. PASCO

ICT Coordinator
Tagum National Trade School
Tagum, Davao del Norte - Region XI

REVIEWERS

GIL P. CASUGA

Chief TESD Specialist, TESDA

REYNALDO S. DANTES

Senior TESD Specialist, TESDA

MARIA A. ROQUE

Senior TESD Specialist, TESDA

BERNADETTE S. AUDIJE

Senior TESD Specialist, TESDA

VICTORIO N. MEDRANO

Principal IV, SPRCNHS

PARALUMAN R. GIRON, Ed.D.

Chair, Sub-TWG on K to 10

BRENDA B. CORPUZ, Ph.D.

TA for K to 12 Curriculum

OFELIA O. FLOJO

Retired Assistant Chief, EED, Region IV-A

BEATRIZ A. ADRIANO

Principal IV, ERVHS

AIDA T. GALURA

VSA II, ACNTS

DOMINGA CAROLINA F. CHAVEZ

Principal II, MBHS

DOCUMENTORS / SECRETARIAT

PRISCILLA E. ONG

K to 12 Secretariat

FREDERICK G. DEL ROSARIO

Head Teacher III, BNAHS

EMMANUEL V. DIONISIO

Head Teacher III, AFGBMTS

LYMWEL P. LOPEZ

Teacher I, AFGBMTS

DANTE D. VERMON JR.

Teacher I, AFGBMTS

CHERLYN F. DE LUNA

Teacher I, AFGBMTS

JOANNA LISA C. CARPIO

Teacher I, BNAHS

ROMANO T. LOPEZ

Teacher I, BNAHS

Dir. IMELDA B. TAGANAS

*Executive Director, Qualifications Standards Office
K to 12 Learning Area Team Convenor, TLE/TVE*